

# Some problems in computational neurobiology

Jan Karbowski

California Institute of Technology

# Plan of the talk

- Neurobiological aspects of locomotion in the nematode *C. elegans*.
- Principles of brain organization in mammals: architecture and metabolism.
- Self-organized critical dynamics in neural networks.

# Physics and Biology have different styles in approaching scientific problems

- **Biology:** mainly experimental science, theory is descriptive, mathematics is seldom used and not yet appreciated.
- **Physics:** combines experiment and theory, theory can be highly mathematical and even disconnected from experiment.

# Brains compute!

Brains perform computation i.e. transform one set of variables into another in order to serve some biological function (e.g. visual input is often transformed into motor output).

The challenge is to understand neurobiological processes by finding unifying principles, similar to what has happened in physics.

# Size of the nervous system

Brains can vary in size, yet the size in itself is not necessarily beneficial. What matters is the proportion of brain mass to body mass.

Nematode *C. elegans* has 300 neurons while human brain has 10 billions neurons!

# *C. elegans*

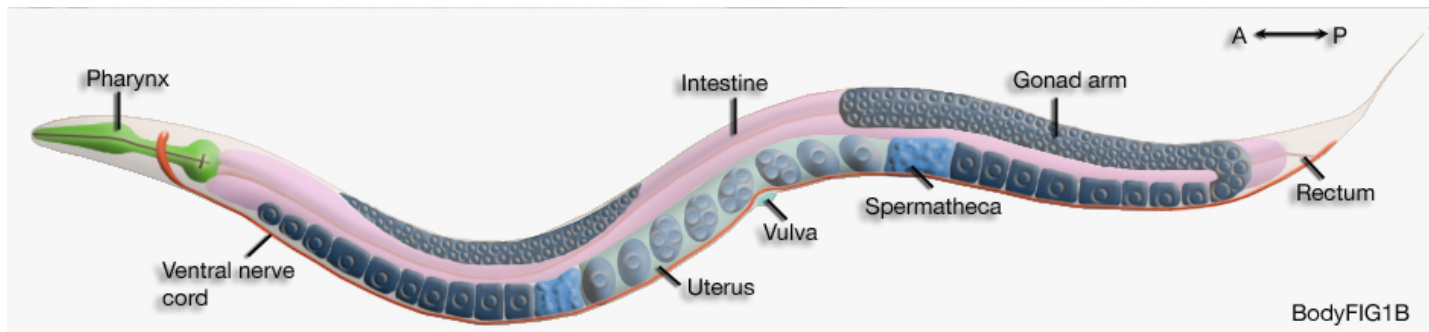
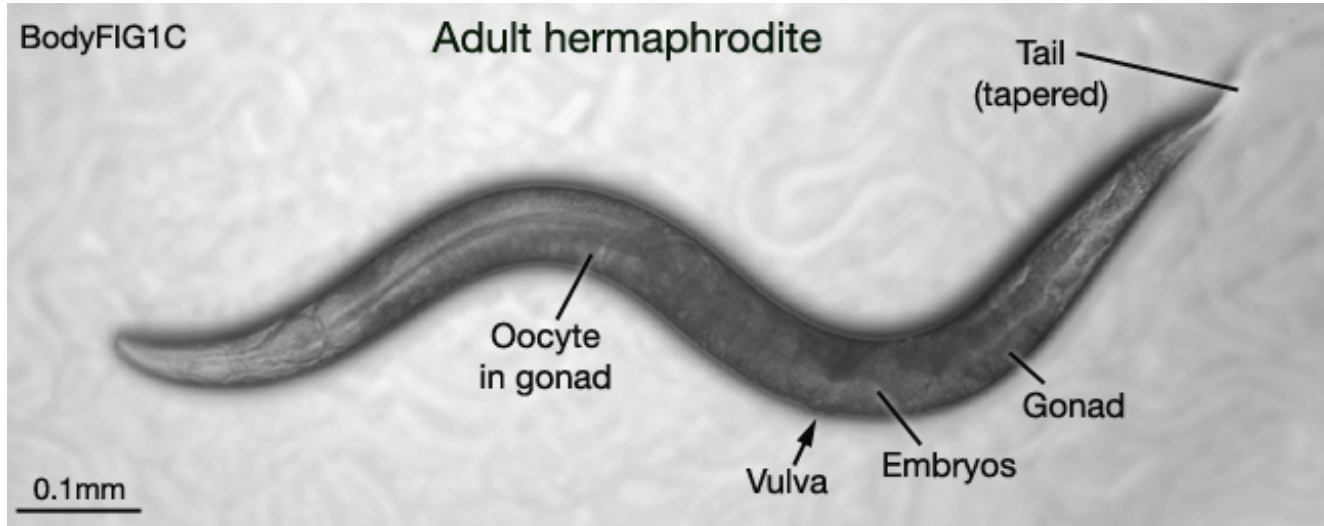





















# Why do we care about *C. elegans* worms?

- *C. elegans* are the most genetically studied organisms on the Earth.
- They have a simple nervous system and their behavioral repertoire is quite limited, which may be amenable to quantitative analysis.
- Understanding of their behavior may provide clues about behavior of higher order animals with complex nervous systems.



# What is the problem?

Locomotion is the main behavior of *C. elegans*. However, despite the identification of hundreds of genes involved in locomotion, we do not have yet coherent molecular, neural, and network level understanding of its control.

## The goal:

To reveal the mechanisms of locomotion by constructing mathematical/computational models.

# What parameters do we measure?

Velocity (centroid) - mean velocity of points 5-13

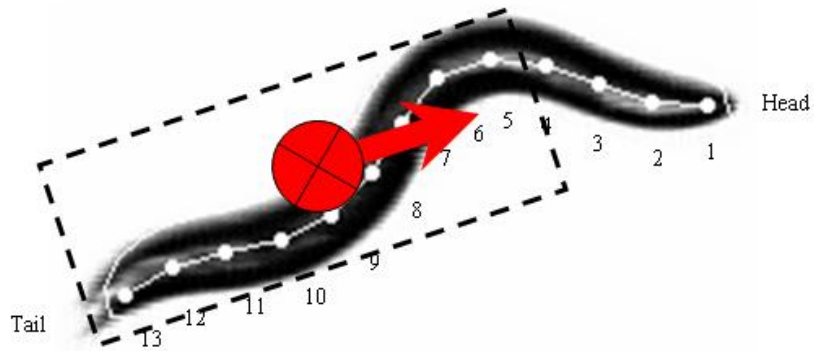

Bending Frequency

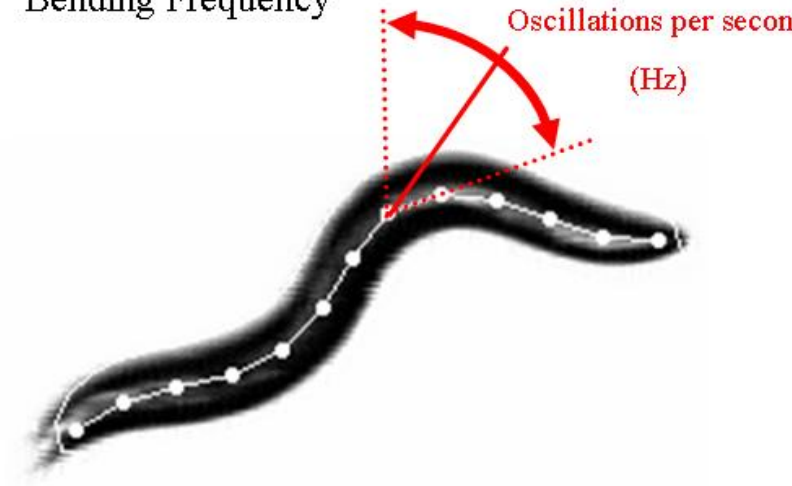

Track Amplitude

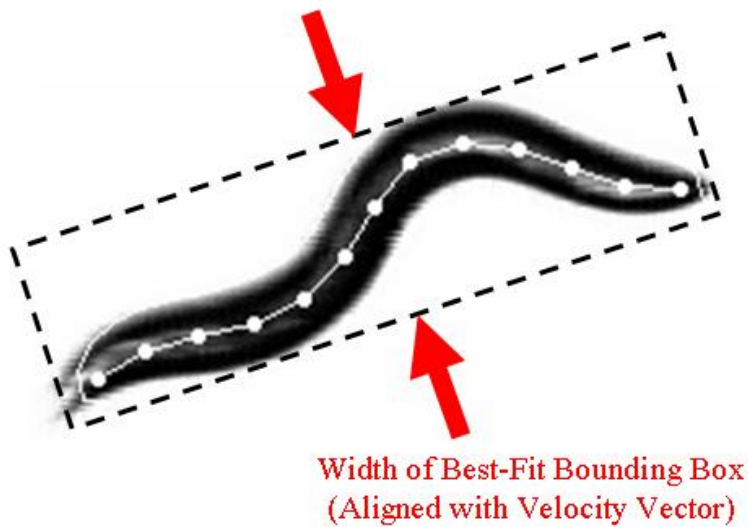

Track Wavelength

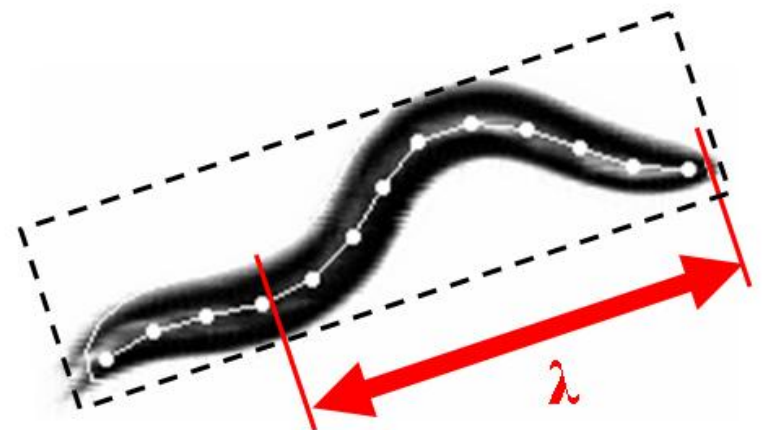

# Biomechanical aspects of movement

- Scaling of the velocity of motion,  $v$ , with the velocity of muscular wave,  $\lambda\omega/2\pi$ :

$$v = \gamma (\lambda\omega/2\pi)$$

where the efficiency coefficient  $\gamma$  is  $0 < \gamma < 1$ .

Conserved  $\gamma$  across different mutants of *C. elegans* and different *Caenorhabditis* species.

# Conservation of the coefficient $\gamma$ (the slope)

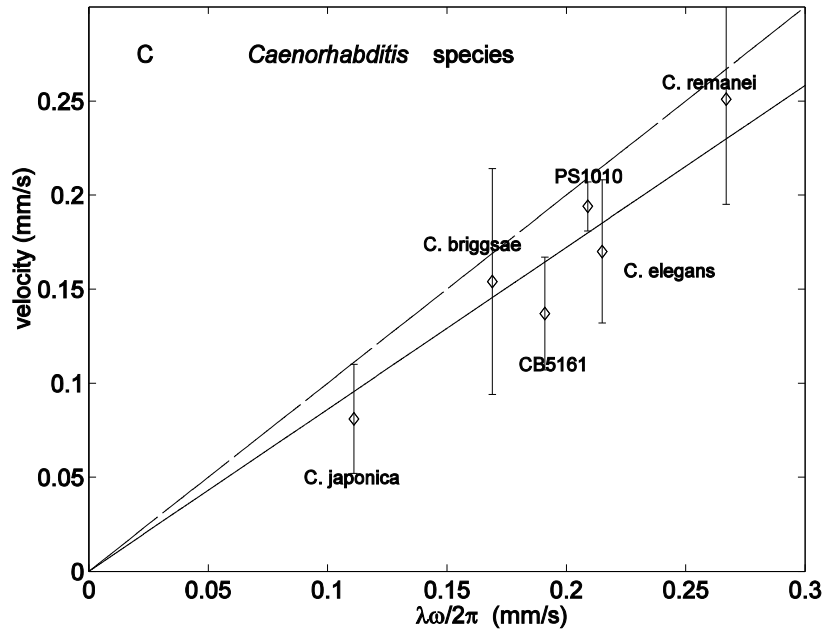
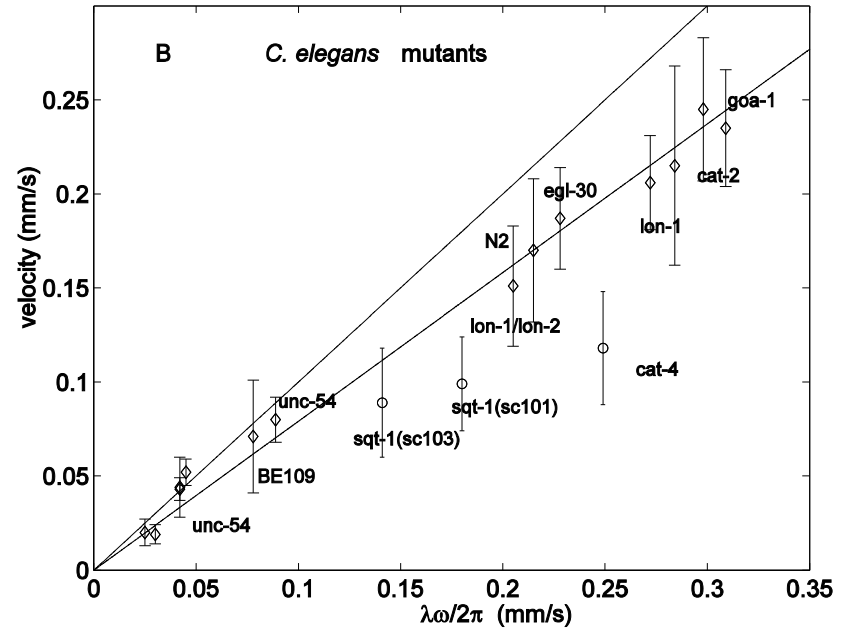
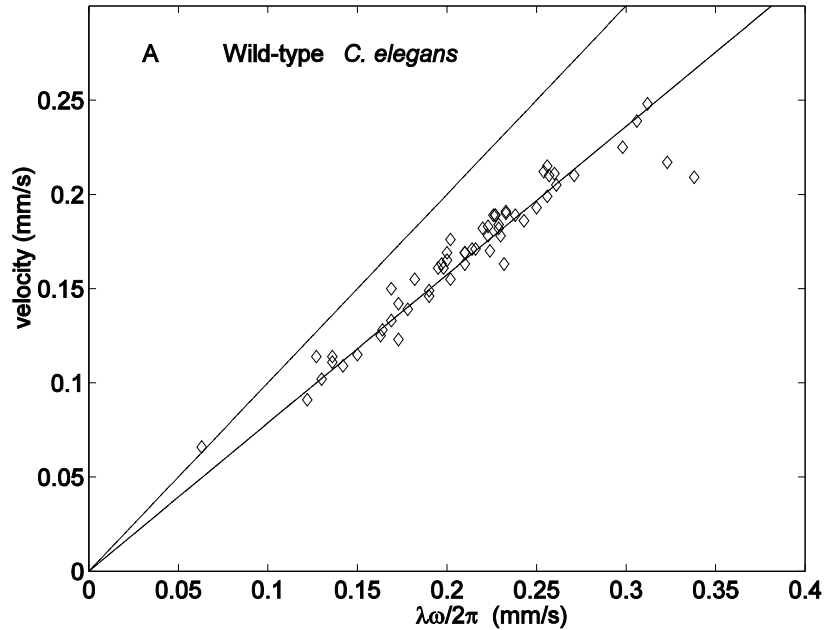

The slope  $\gamma$  is around 0.8 in all three figures, thus close to optimal value 1, across a population of wild-type *C. elegans*, their mutants, and related species.

# Conservation of normalized wavelength

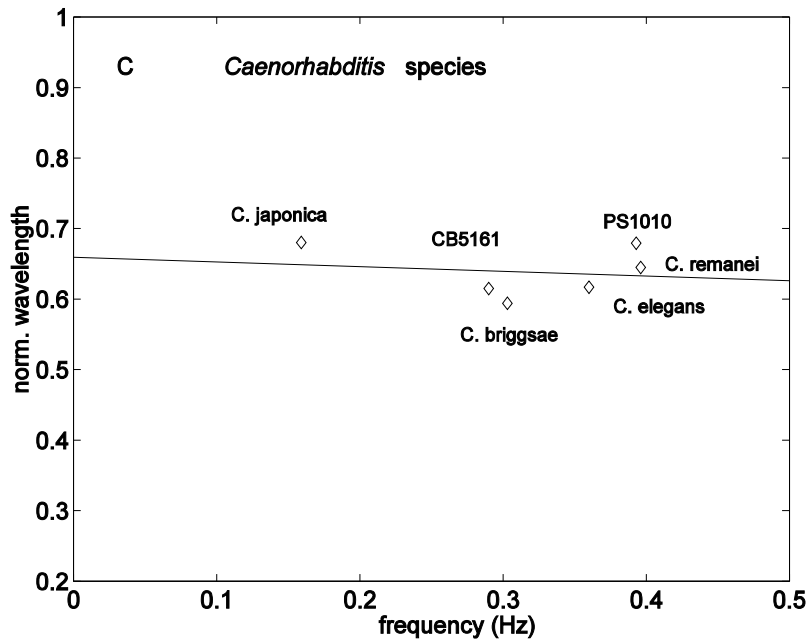
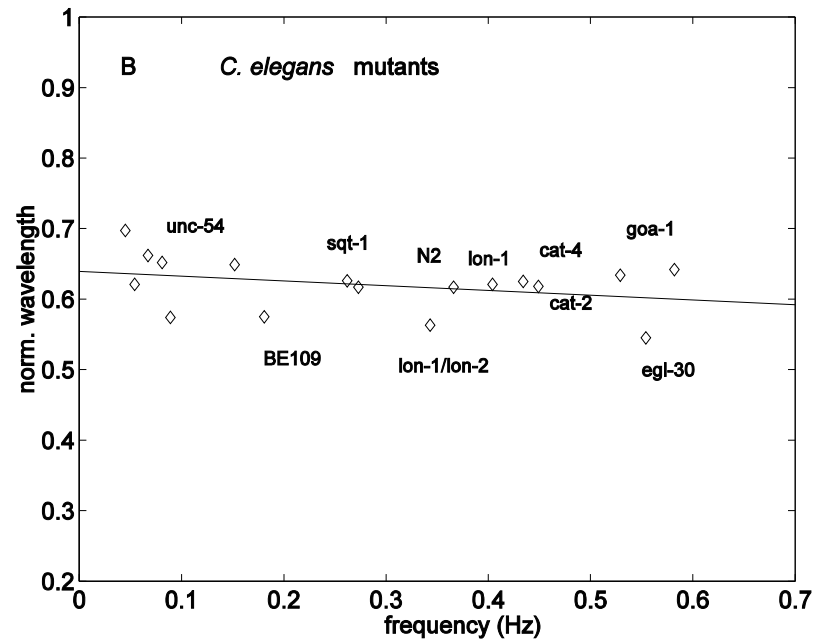
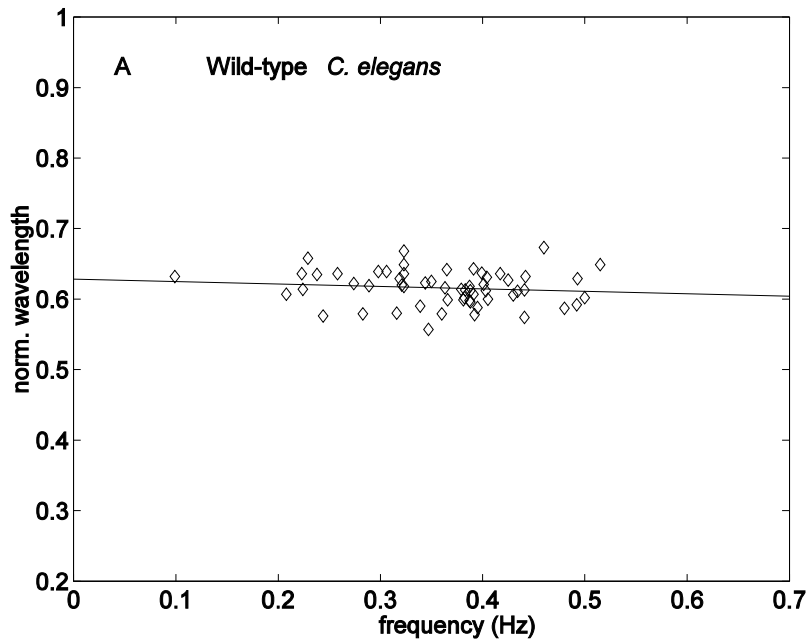

The normalized wavelength  $\lambda/L$  is around  $2/3$  in all three figures. Thus, it is conserved across a population of wild-type *C. elegans*, their mutants, and related species.

## Amplitude depends on several parameters

$$A \propto \lambda \left[ \left( 1 + a^2 \omega^2 \right) \left( 1 + b^2 \omega^2 \right) \right]^{-1/2}$$

Parameters  $a$  and  $b$  depend on a magnitude of synaptic transmission at the neuromuscular junction, on muscle rates of contraction-relaxation cycle, and on visco-elastic properties of the worm's skeleton/cuticle.

# Linear scaling of amplitude with wavelength during development

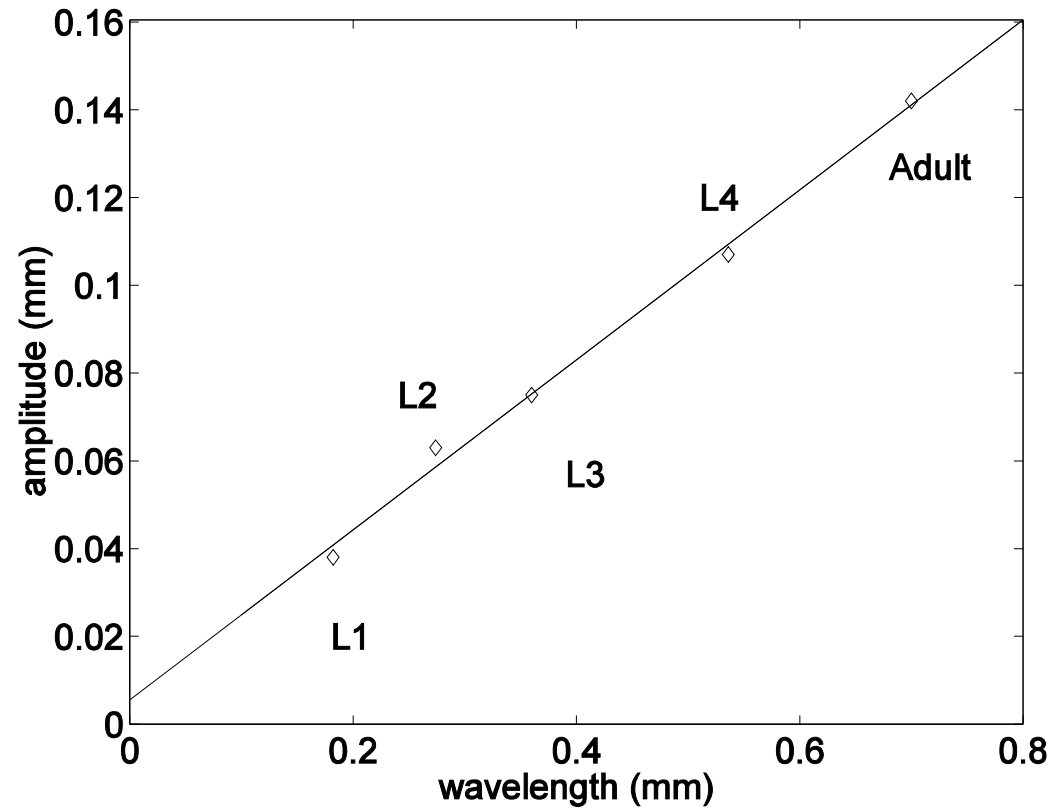

These results suggest that the movement control is robust despite genetic perturbations.



# What causes body undulations or to what extent the nervous system controls behavior?

- Neural mechanism of oscillation generation: Central Pattern Generator (CPG) somewhere in the nervous system.
- Mechano-sensory feedback: nonlinear interaction between neurons and body posture.

Both mechanism generate oscillations via Hopf bifurcation.  
Data suggest that oscillations are generated in the head.

# Gradients of the bending flex along the worm's body

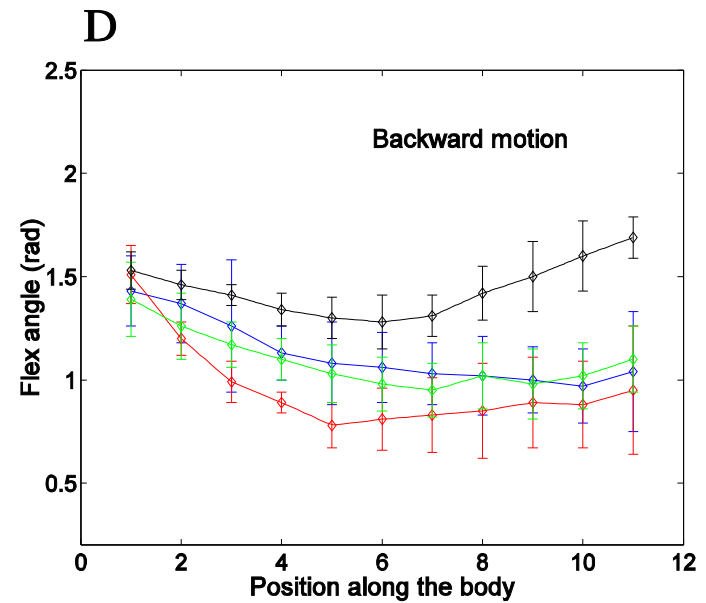
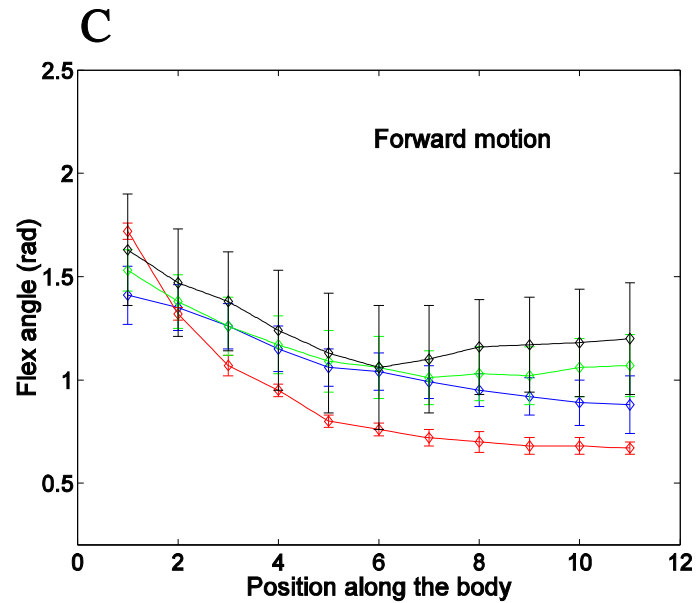
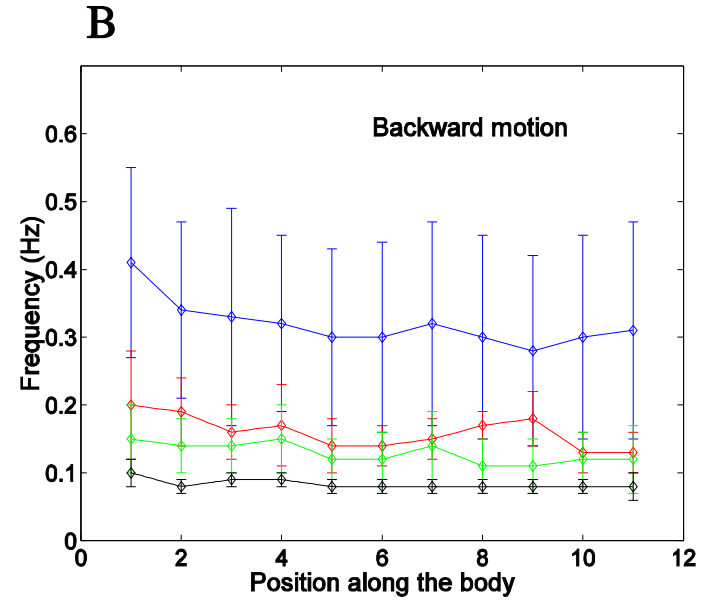
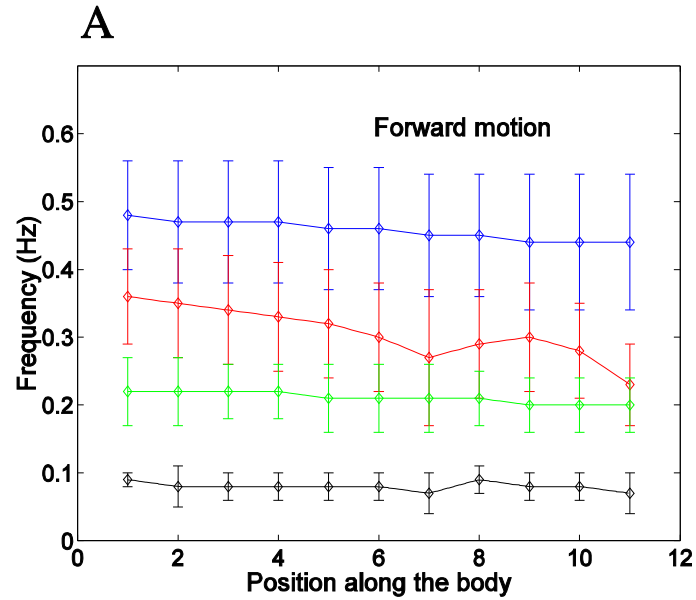

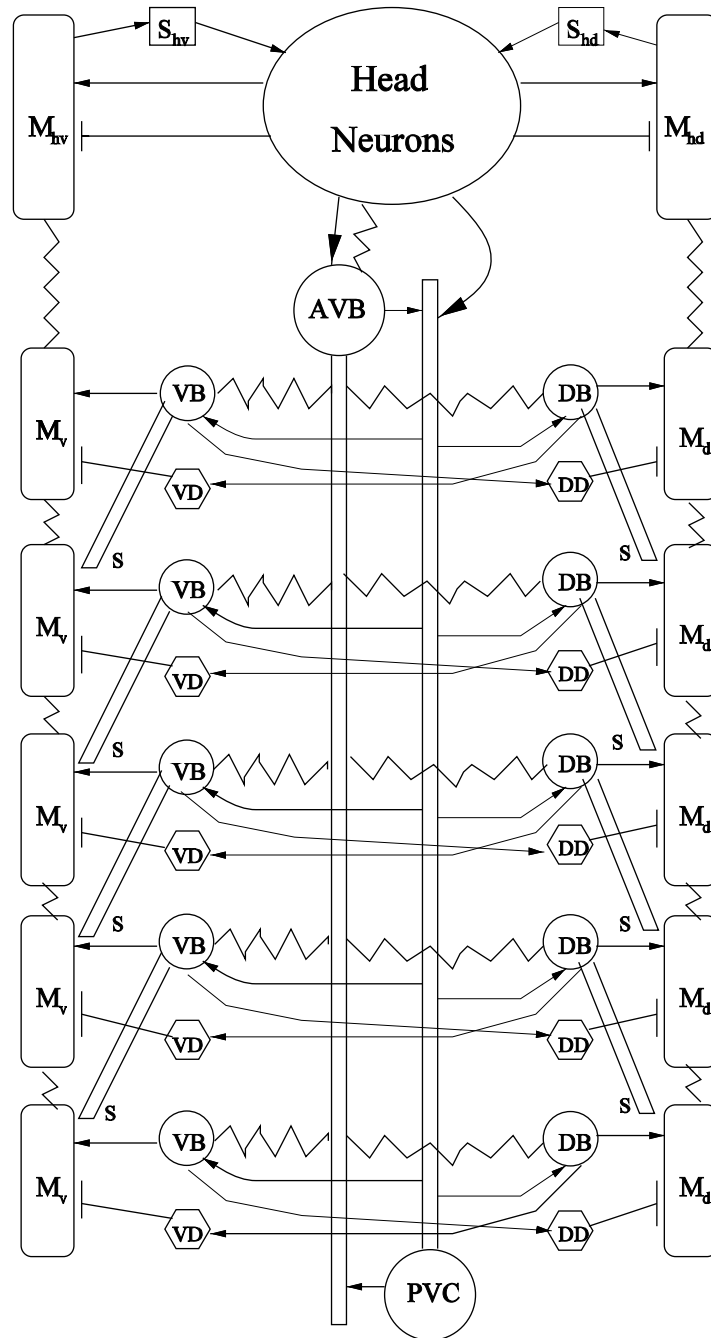

*C. Elegans*  
neural circuit

# Dynamics of the circuit

$$\tau_e \frac{dE_V}{dt} = -E_V + H_e(A - \varepsilon S_V)$$

$$\tau_i \frac{dI_V}{dt} = -I_V + H_i(\kappa E_D)$$

$$\tau_m \frac{dM_V}{dt} = -\gamma M_V + H_m(M_V) + \alpha E_V - \beta I_V$$

$$\tau_s \frac{dS_V}{dt} = -S_V + H_s(M_V)$$

The circuit model can generate oscillations...

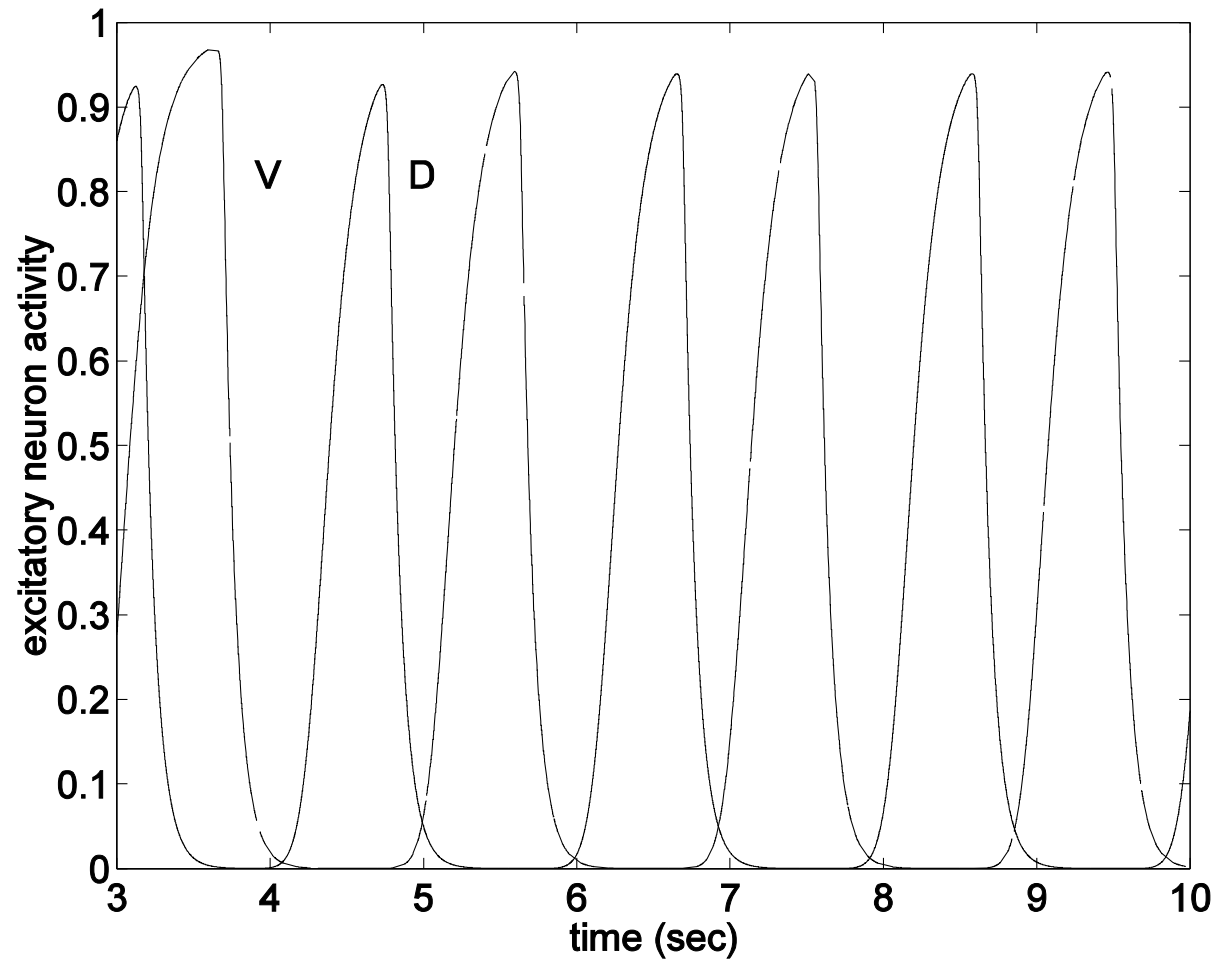

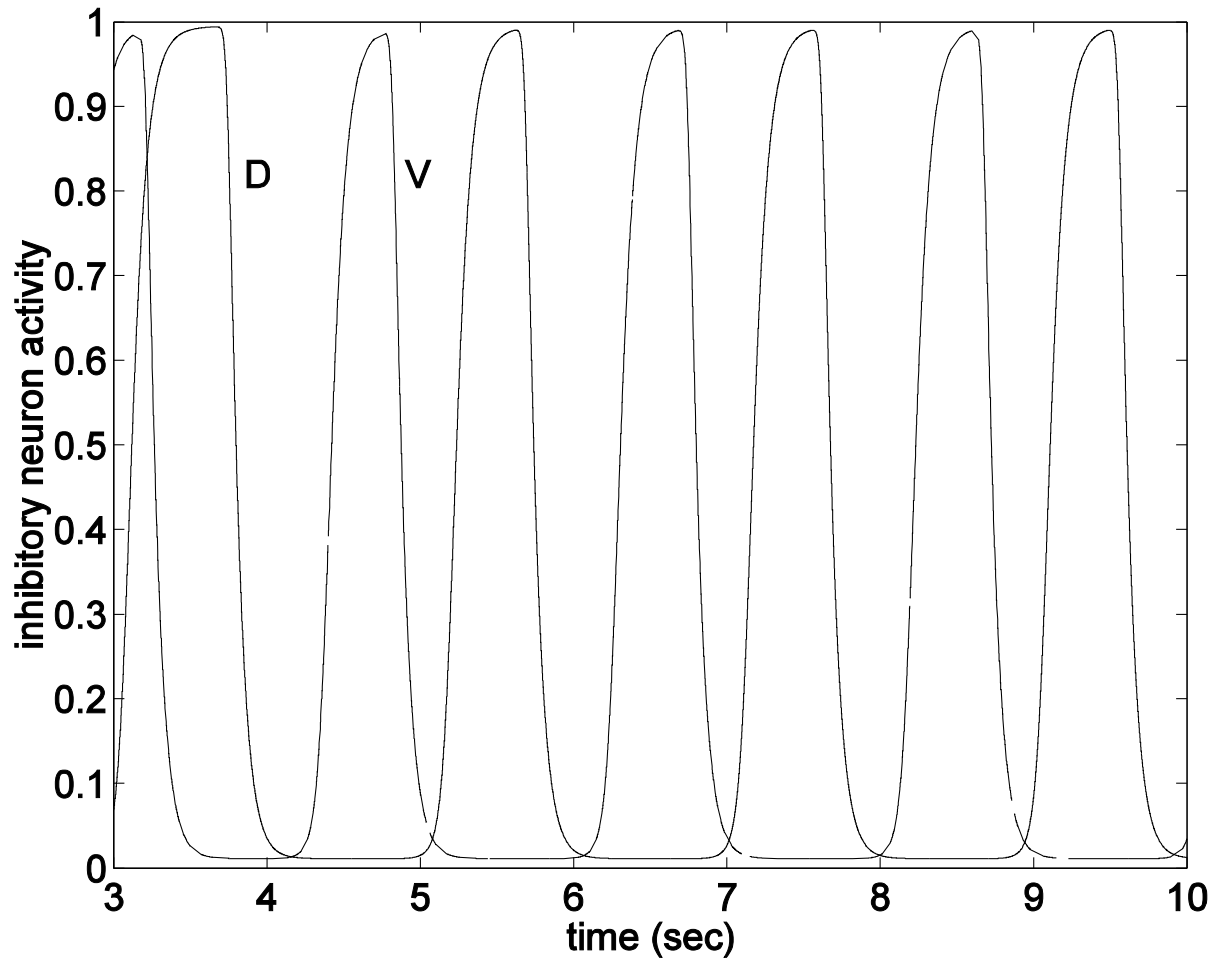

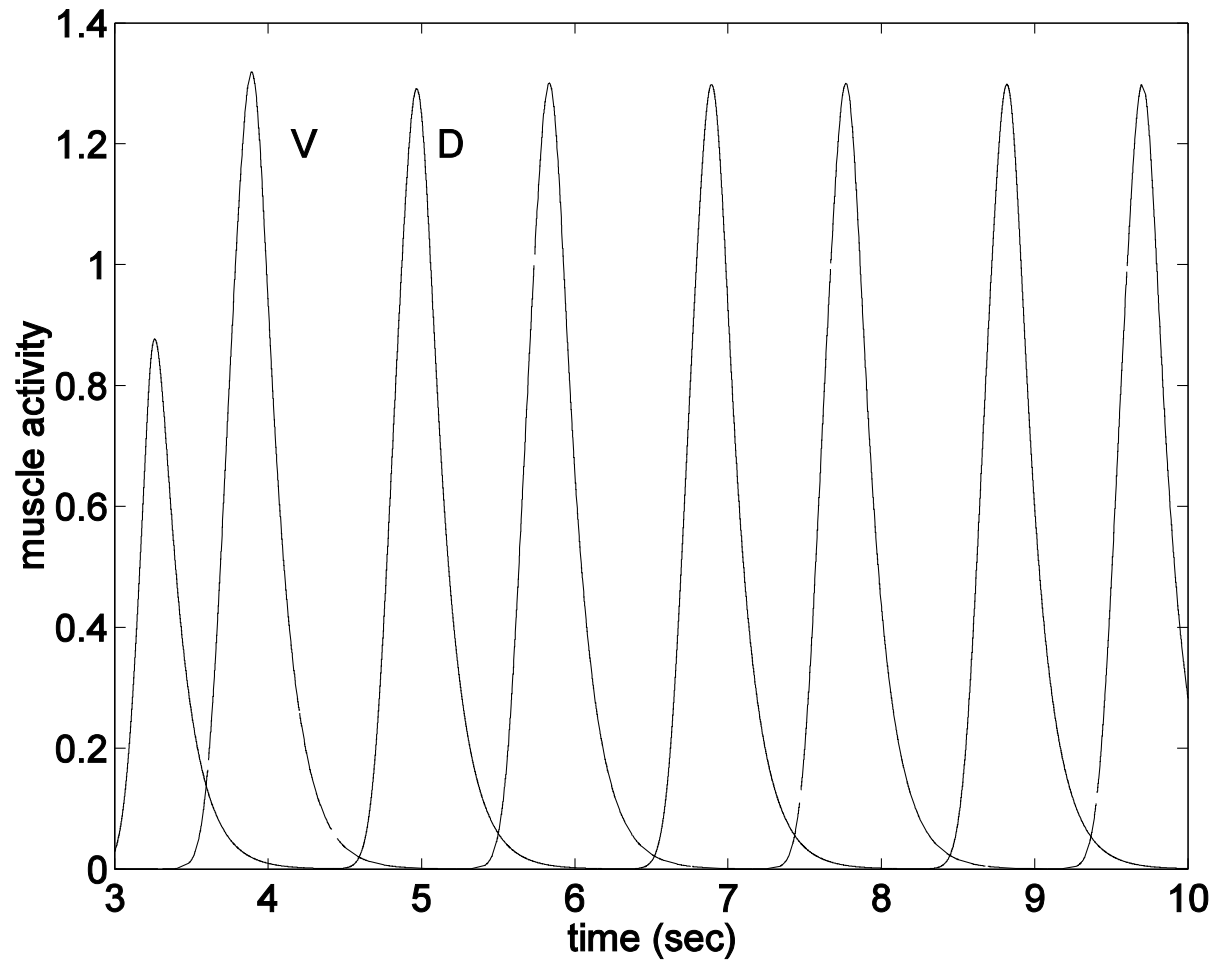



# Coupled oscillators diagram

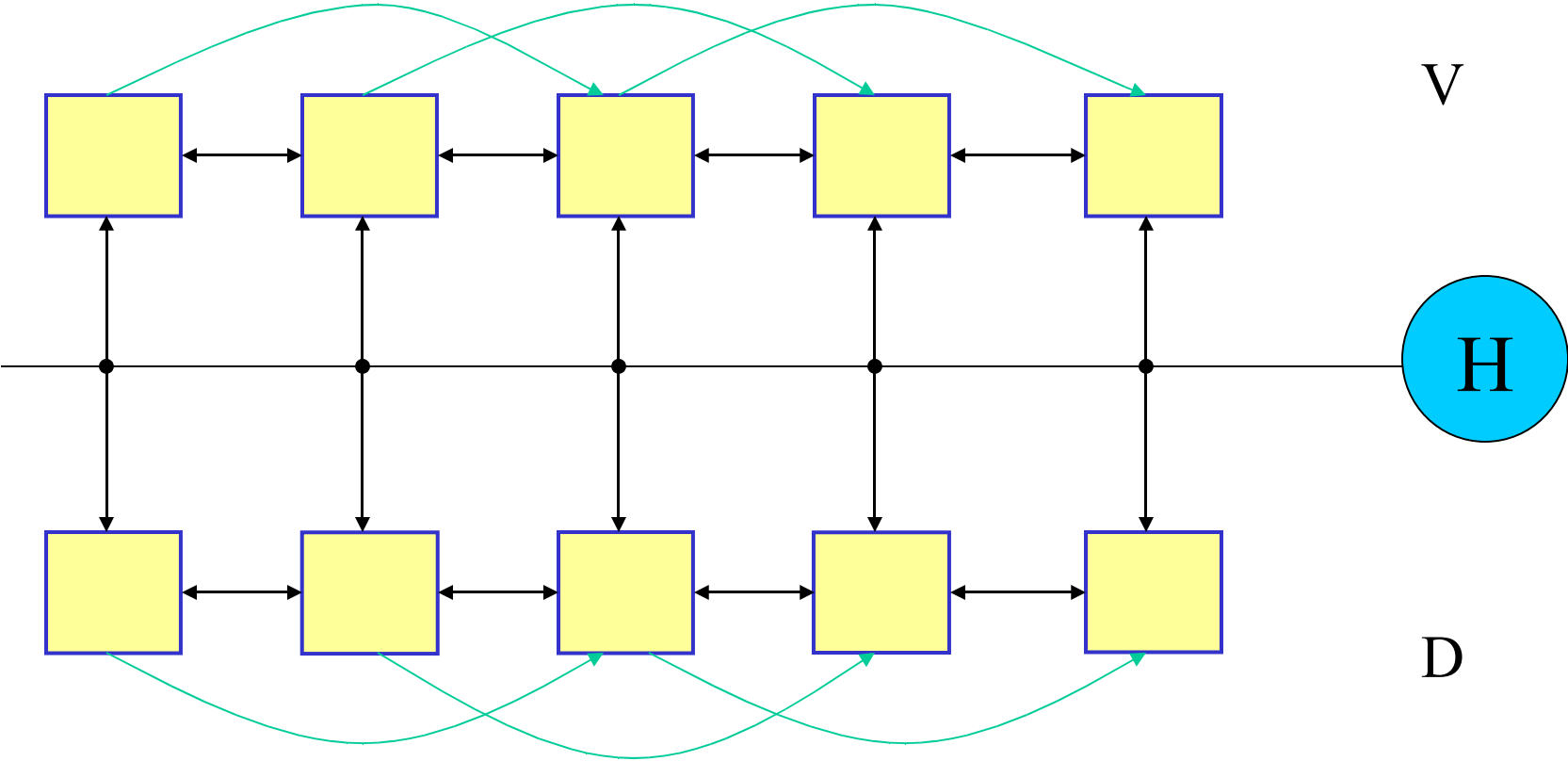

← Direction of neuromuscular wave

Direction of worm's motion →

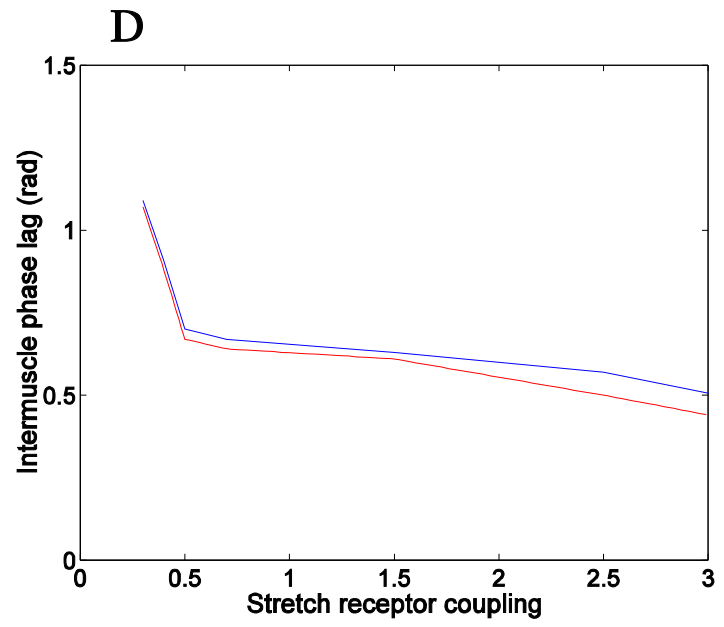
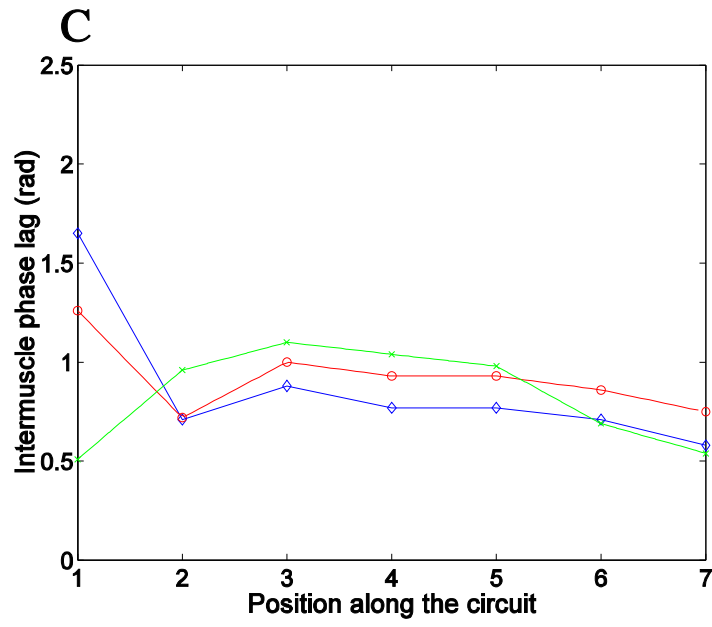
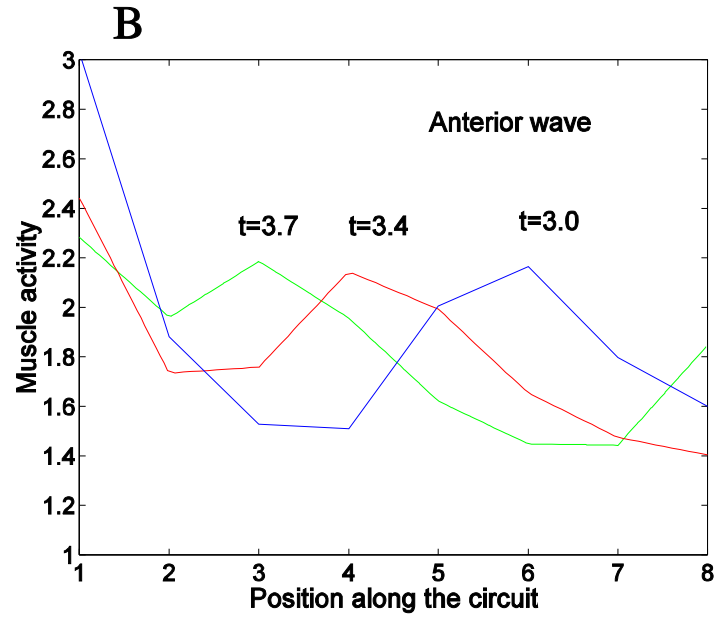
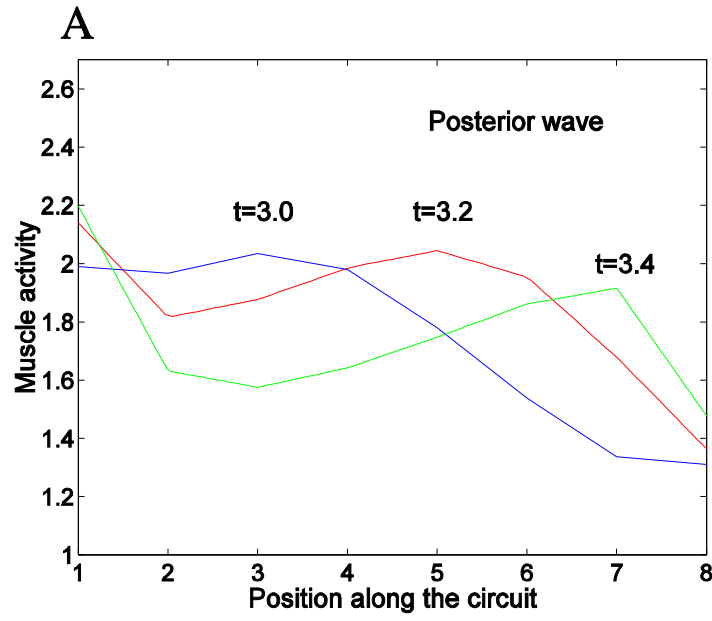

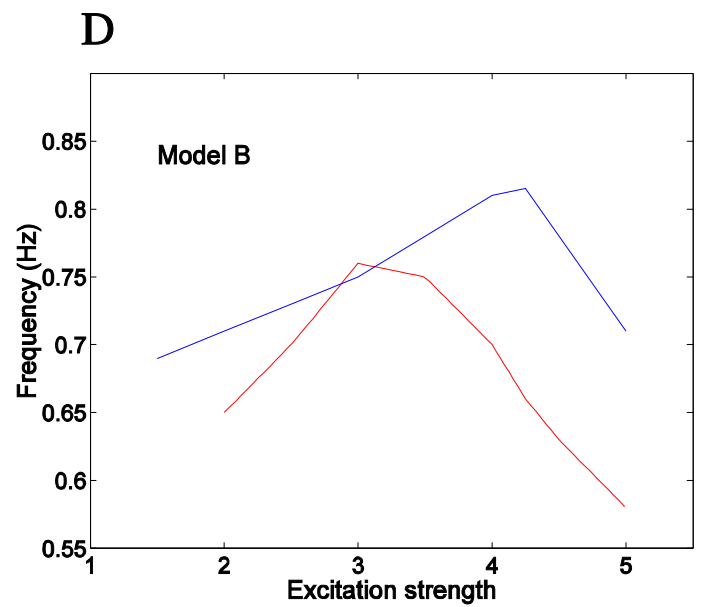
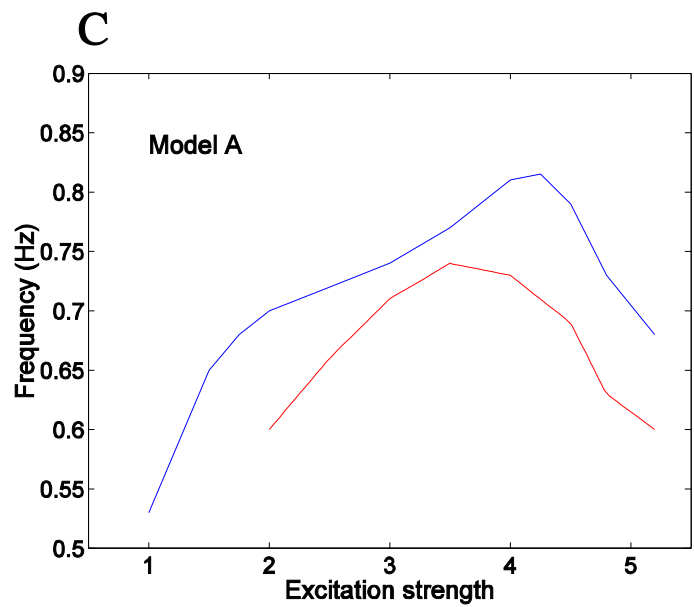
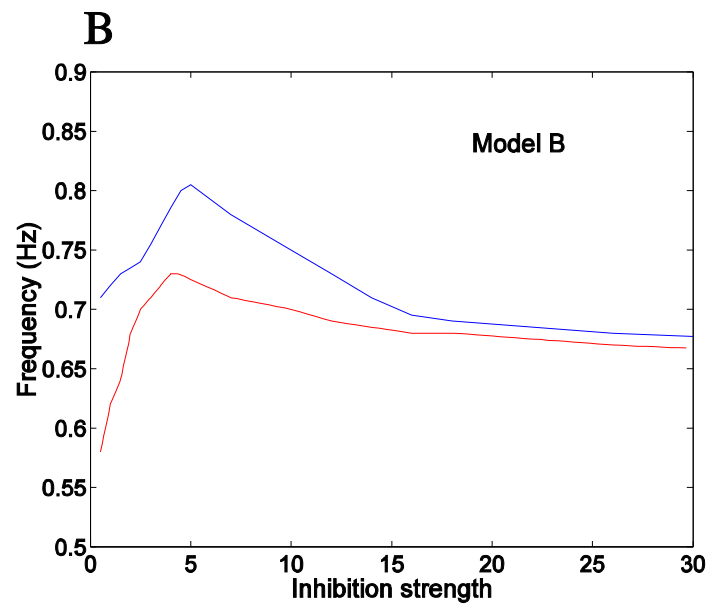
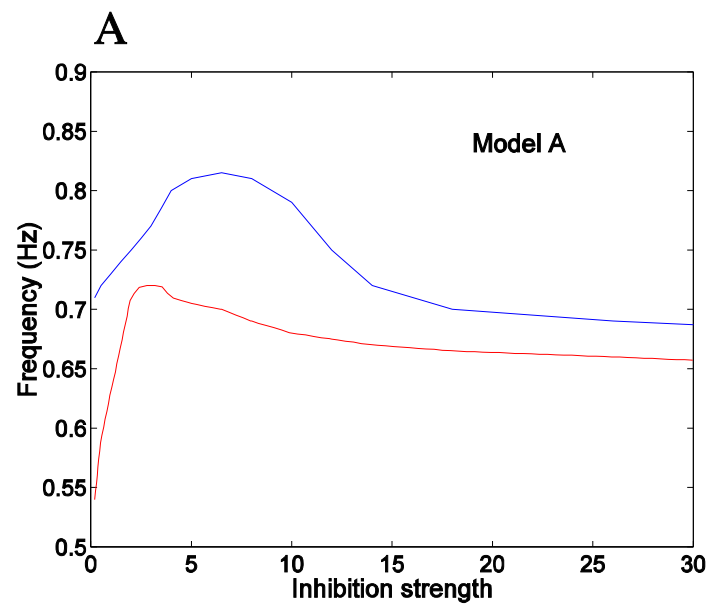

Change of subject: 20 seconds for relaxation!

# Conserved relations in the brain design of mammals

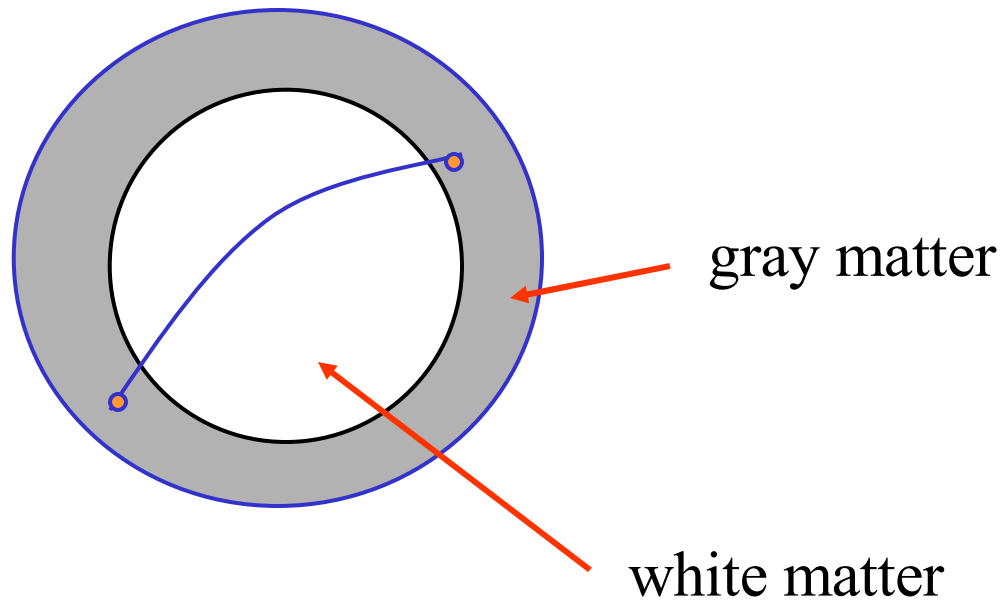

# Conserved cortical parameters

- Volume density of synapses.
- Surface density of neurons.
- Volume density of intracortical axonal length.

These parameters are invariant with respect to brain size and cortical region (Braitenberg and Schuz, 1998).

## Modularity and regularity in the cortex

- Number of cortical areas scales with brain volume with the exponent around 0.4 (Changizi 2001).
- Module diameter scales with brain volume with the exponent  $1/9$  (Changizi 2003; Karbowski 2005).
- White matter volume scales with gray matter volume with the exponent around  $4/3$  (Prothero 1997; Zhang & Sejnowski 2000).

The challenge is to understand the origin of these regularities in the brain in terms of mathematical models ...



## From these invariants one can derive scaling relations for neural connectivity...

- Probability of connection between two neurons scales with brain size as:

$$p \propto V_g^{-0.8}$$

- Probability of connections between two cortical areas scales with brain size as:

$$Q \approx 1 - \exp(-a \cdot V_g^{-0.28})$$

(Karbowski, 2003)

# Trade-offs in the brain design and function

The ratio of white and gray matter volumes depends on functional parameters: number of cortical areas  $K$ , their connectivity fraction  $Q$ , and temporal delay between areas  $\tau$  as follows

$$\frac{V_w}{V_g} \propto V_g^{-0.1} \frac{K^3 Q^{3/2}}{\tau^2}$$

Thus maximization of  $K$  and minimization of  $\tau$  causes excessive increase of wire (white matter) in relation to units processing information (gray matter) as brain size increases. This leads to a trade-off between functionality and neuroanatomy (Karbowski 2003).

# Non-uniform brain activity pattern

(Phelps & Mazziotta, 1985)

epilepsy, and various developmental disorders of the brain. In patients with partial seizure disorders (symptoms referable to a limited region of the brain), interictal studies (between seizures) with FDG have identified areas of decreased glucose utilization in 70 percent of affected individuals (Fig. 2a) (17). These zones could be correlated with the site of maximal abnormalities determined by surface and depth electrode electrophysiological techniques, and were found to be extremely specific in identifying sites of microscopic pathology not detected by the conventional radiological imaging techniques such as x-ray CT, angiogra-

phy, and pneumo-encephalography (17). During seizure activity (ictal period), sites that show low glucose utilization interictally show increased utilization (often increasing by 100 to 200 percent) (Fig. 2a); this suggests that the interictal low glucose utilization is at least in part due to nonstructural causes (17, 18). The sites of increased glucose utilization during the ictal phases of partial seizures correlated both with the behavior of the patient and with spikes recorded from scalp and particularly depth electroencephalographic (EEG) recordings (Fig. 2a) (17, 18). Patients with generalized forms of epilepsy (such as major motor

or petit mal seizures) have global (that is, throughout the brain) increases in glucose utilization in the ictal period of seizure activity with subsequent depression in glucose utilization in the postictal period (19).

The finding of interictal zones of hypometabolism, particularly in the temporal lobe of partial epilepsy patients, has suggested that this may be specific for a lowered threshold or greater susceptibility of these foci to initiation of seizure activity. These findings have in turn promoted a series of parallel studies in animals (glucose utilization, blood flow, morphology, electrophysiology, ligand

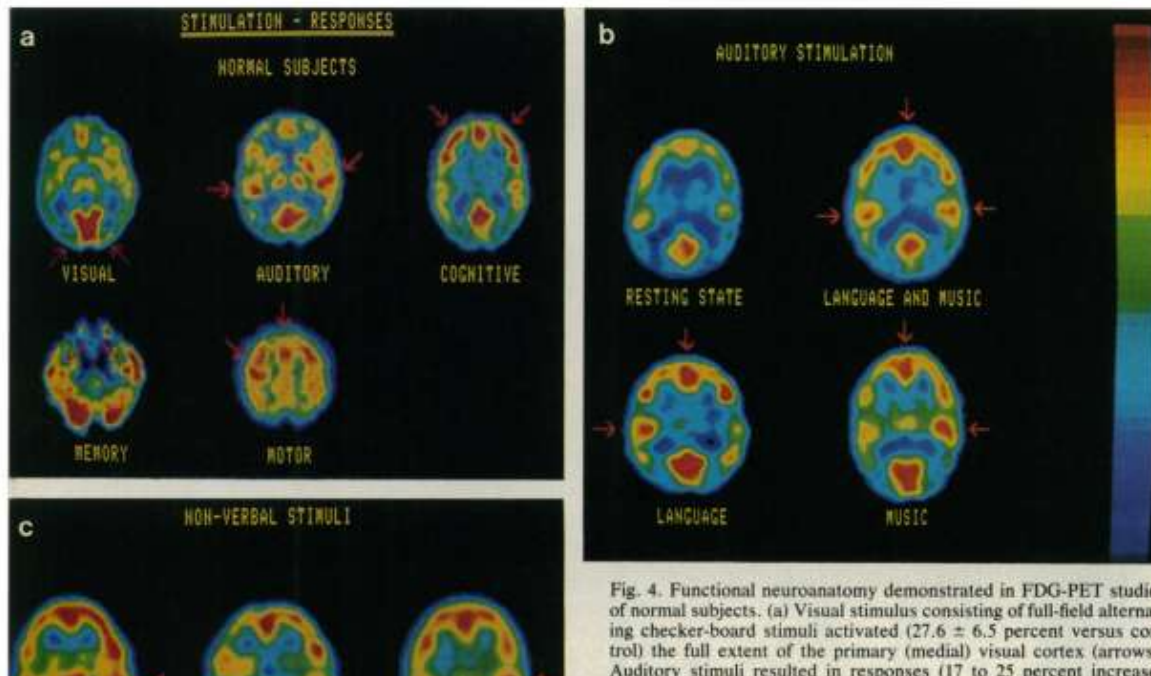
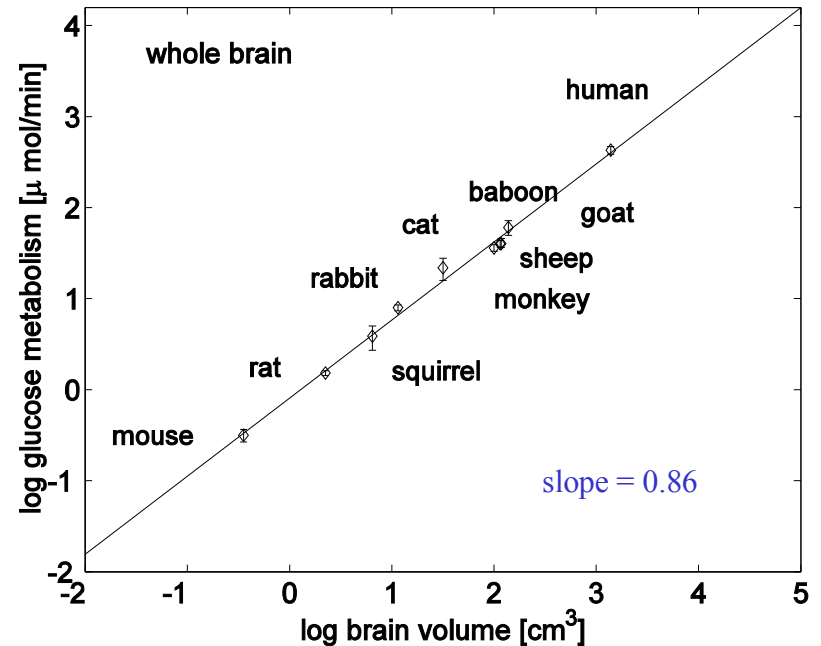
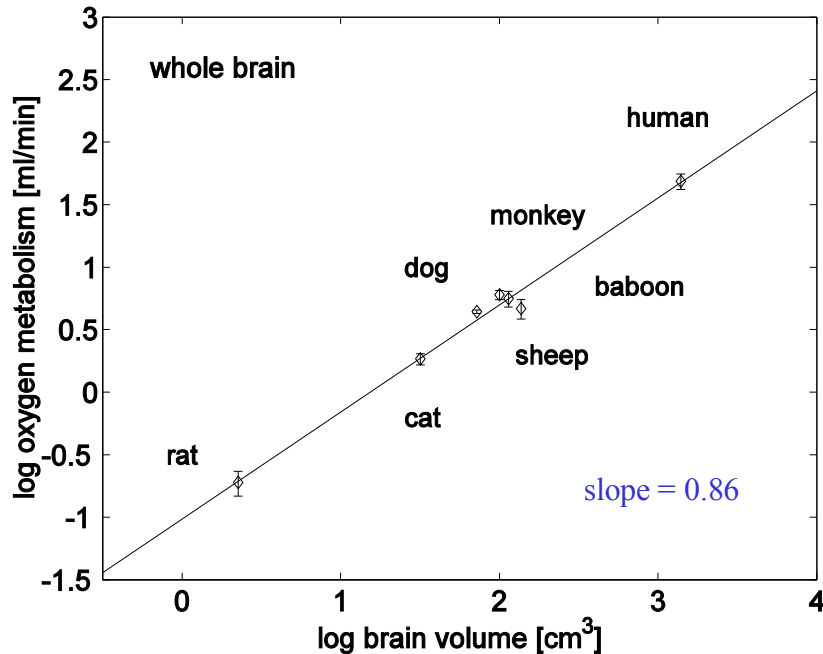

Fig. 4. Functional neuroanatomy demonstrated in FDG-PET studies of normal subjects. (a) Visual stimulus consisting of full-field alternating checker-board stimuli activated ( $27.6 \pm 6.5$  percent versus control) the full extent of the primary (medial) visual cortex (arrows). Auditory stimuli resulted in responses (17 to 25 percent increases

## Global brain metabolic scaling



The scaling exponent (slope) is **0.86** on both figures, which is larger than the exponents  $3/4$  and  $2/3$  found for whole body metabolism (Karbowski 2006). Thus, brain cells use energy in a different way than cells in rest of the body.

Despite heterogeneous brain activity, the allometric metabolic scaling of its different gray matter structures is highly homogeneous with the specific scaling exponent close to  $-1/6$ .

The specific scaling exponent for other tissues in the body is either  $-1/4$  or  $-1/3$ .

# Regional brain metabolic scaling: cerebral cortex

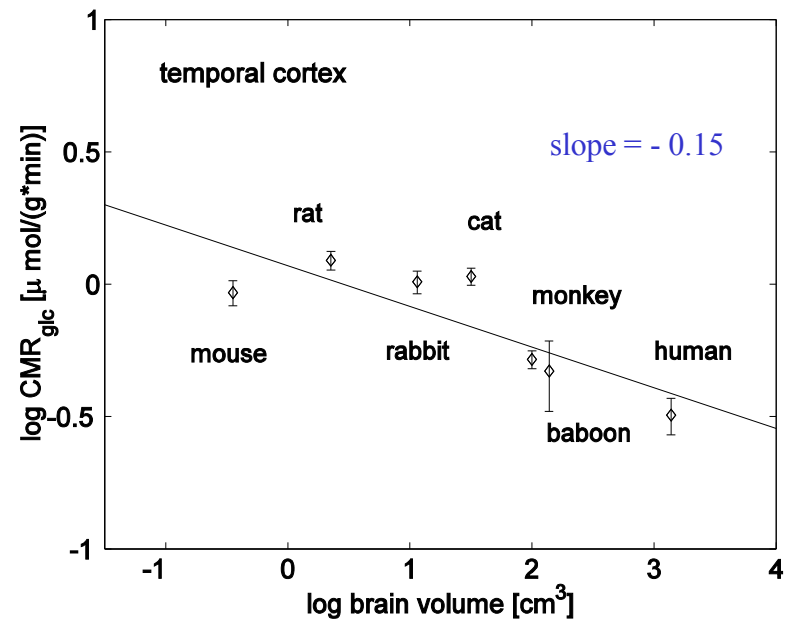
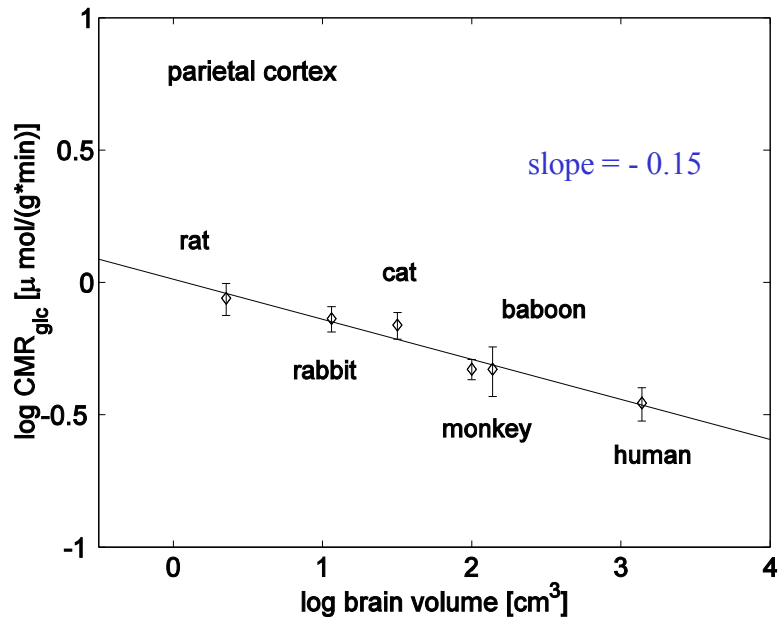
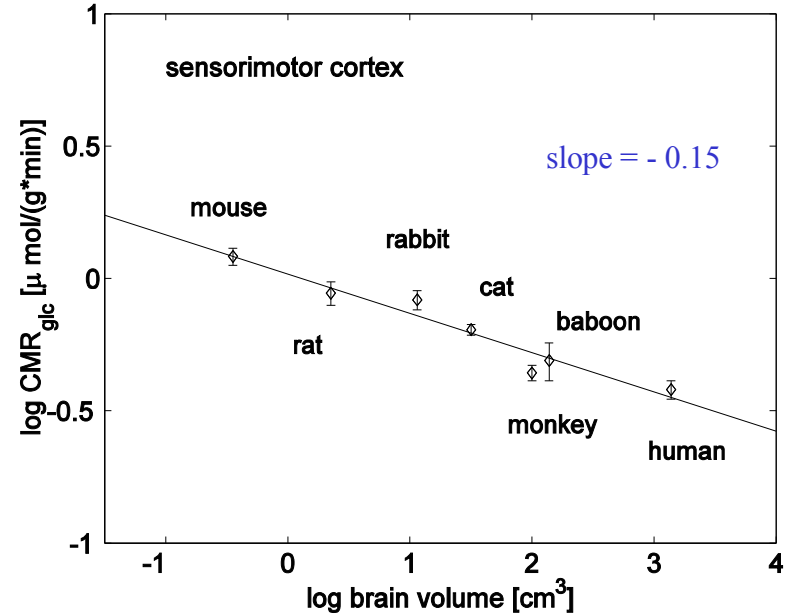
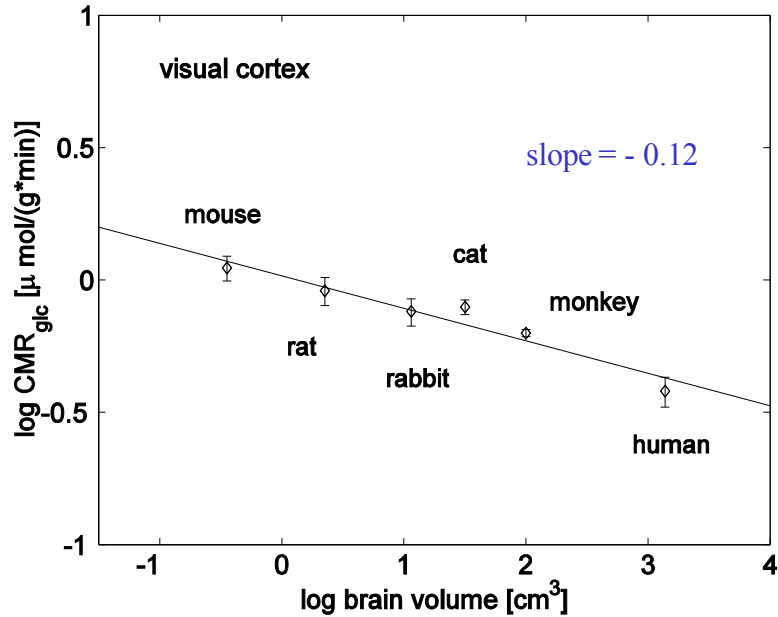

# Regional brain metabolic scaling: subcortical gray matter

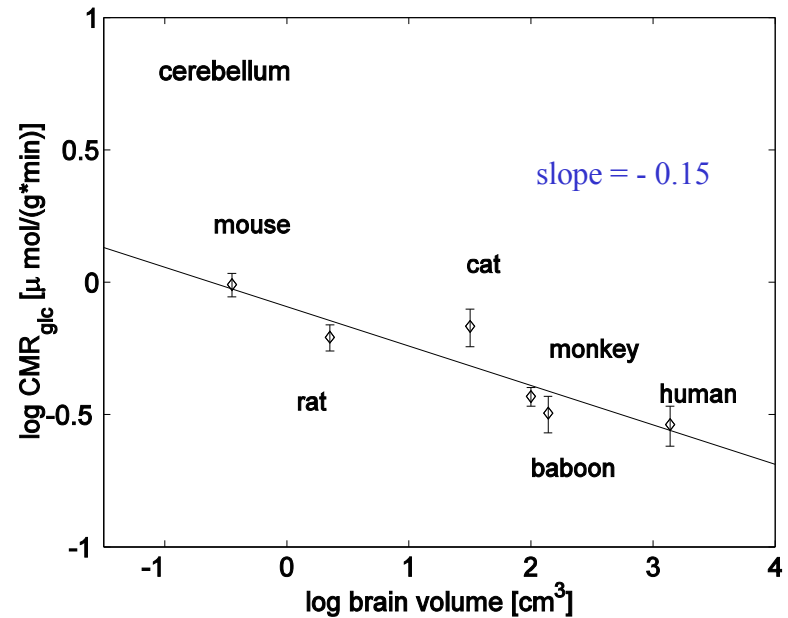
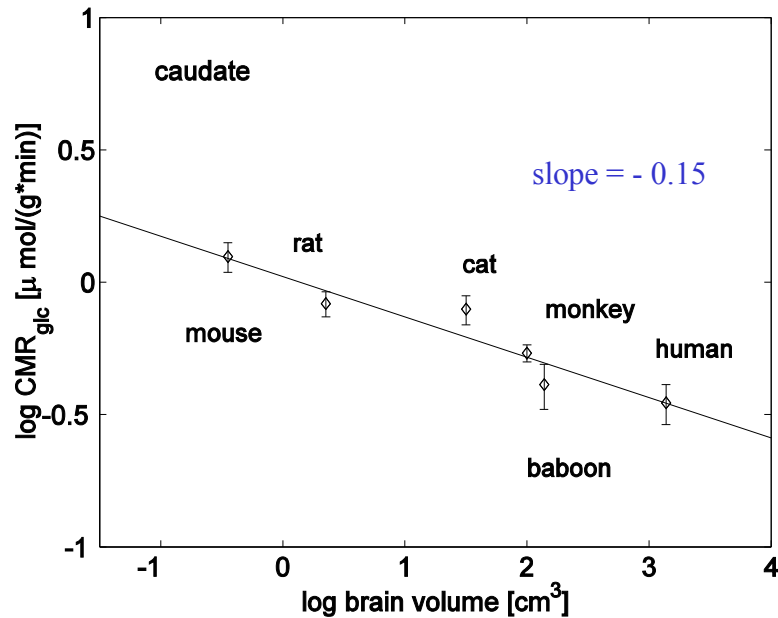
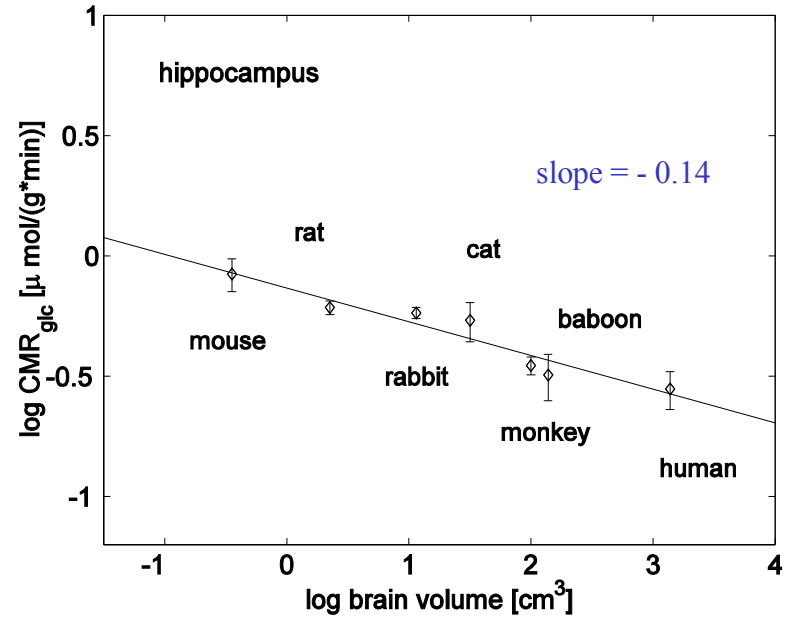
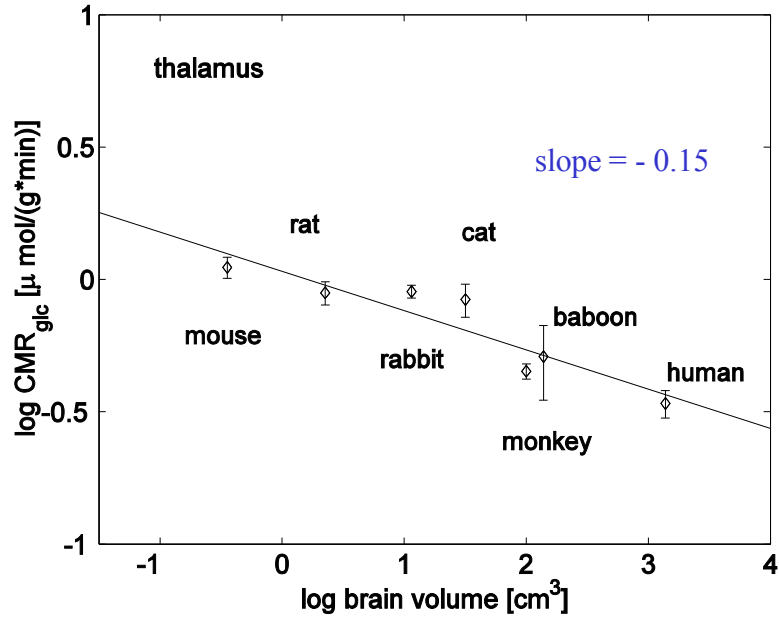

# Self-organized critical networks

SOC first time discovered in condensed matter physics by P. Bak et al in 1987. Later found in many systems ranging from earth-quakes to economy.

Experimental data indicate that neural circuits can operate in an intermediate dynamical regime between complete silence and full activity. In this state the network activity exhibits spontaneous avalanches with single activations among excitatory neurons, which is characterized by power law distributions.



# Mechanism of SOC in neural circuits

- The neural mechanism is unknown yet.
- My recent proposition is based on plasticity of neural circuits: **homeostatic synaptic scaling and conductance adaptation.**

# Homeostatic synaptic plasticity

Discovered experimentally by G. Turrigiano in 1998. The main idea is that synaptic strength adjusts itself to the global level of network activity, i.e., there exists a negative feedback between these two variables – when one increases the second decreases.

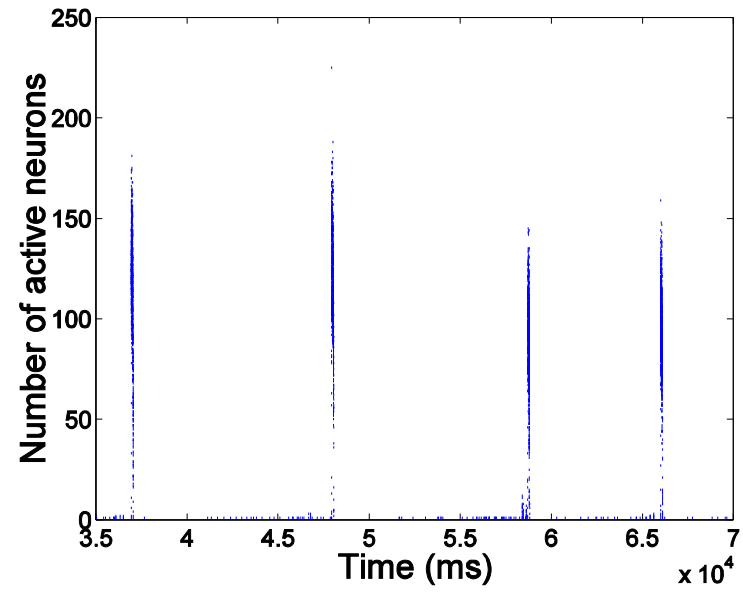
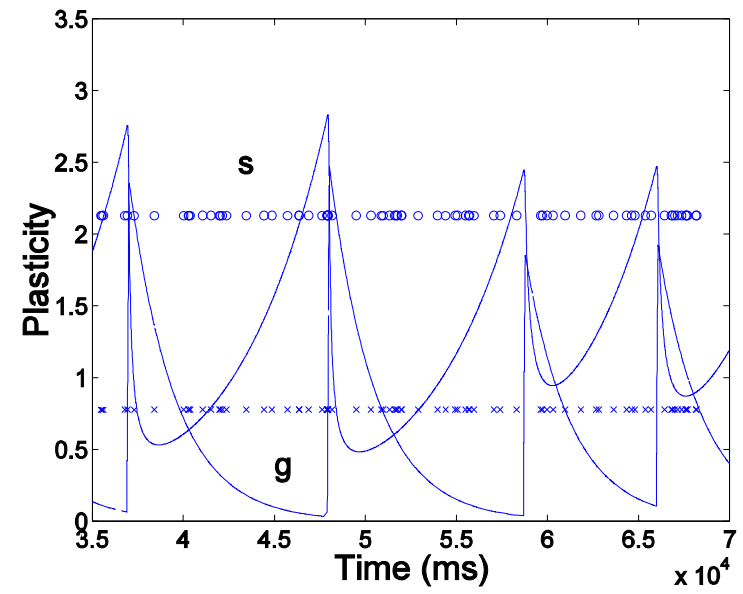
**A****B**

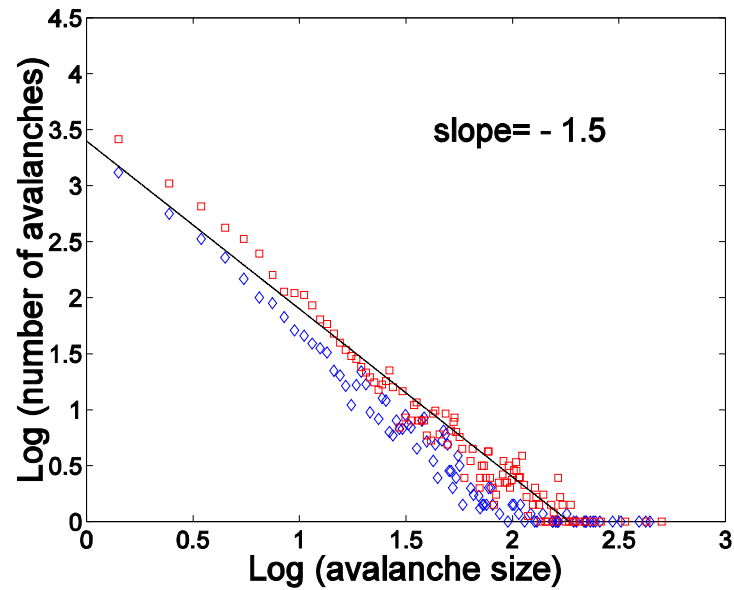
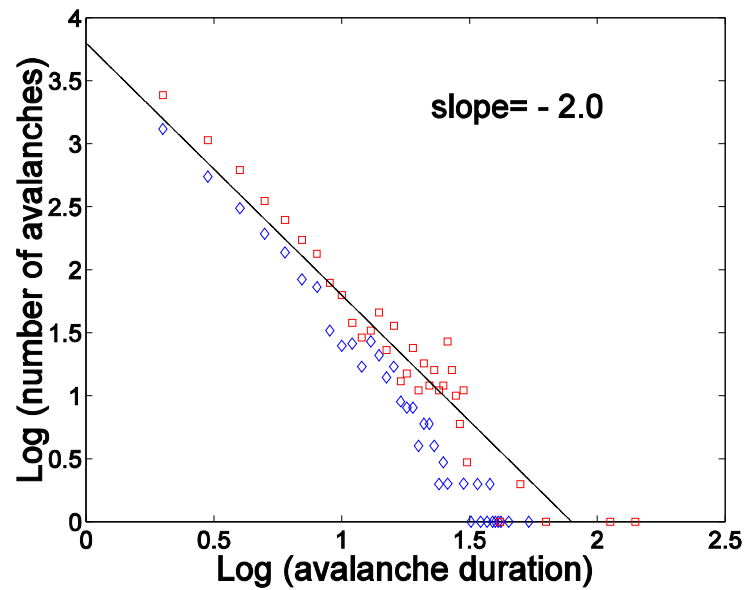
**A****B**

# Summary of results

- The architecture of small brains (*C. elegans* worms) and large brains (mammals) differ. But even simple neural networks are capable of sophisticated motor output.
- Allometry of brain metabolism is different than that of whole body metabolism.
- Plasticity in neural systems can strongly affect the network activity and create highly organized scale-free dynamics.