

DOUBLE PULSE TRANSMISSION – SIGNAL-TO-NOISE RATIO IMPROVEMENT IN ULTRASOUND IMAGING

Ihor TROTS, Andrzej NOWICKI, Marcin LEWANDOWSKI,
Wojciech SECOMSKI, Jerzy LITNIEWSKI

Institute of Fundamental Technological Research
Polish Academy of Sciences
Świętokrzyska 21, 00-049 Warszawa, Poland
e-mail: igotr@ippt.gov.pl

(received April 9, 2008; accepted July 25, 2008)

This study investigates a new composing method of double transmission of short coded sequences based on well-known Golay complementary codes, which allow to obtain the higher signal-to-noise ratio (SNR) and increase penetration depth. The proposed method can potentially find application in small parts ultrasonography and play important role in examination of superficial structures, e.g. in dermatology, ophthalmology, etc., where using longer coded sequences leads to increase of a dead zone and single pulse transmission of short sequences does not assure sufficient SNR.

This paper discusses the comparison of results obtained during the examination of four different lengths pairs of Golay coded sequences excited at 3.7 MHz: the single 64-bits pair of Golay sequences and combined sequences consisting of two 8-, 16-, and 32-bits Golay codes separated in time.

The experimental results have shown that using the double pulse transmission allows to suppress considerably the noise level, the SNR increases by 5.7 dB in comparison with the single pulse transmission of Golay sequences of the same length. The results of this work indicate that double pulse transmission enhances SNR while maintaining the dead zone short.

Keywords: Golay complementary sequences, double pulse transmission, dead zone.

1. Introduction

Permanent development of the ultrasound technique using the coded excitation signals is related to technological progress – from the methods of the wave generation to computer programs, which facilitate the measurements as well as analysis of the changes and monitoring of the treatment of disease. Nowadays coded transmission in ultrasonography is dynamically developing – from parametric imaging of bone in the range 0.5–2 MHz, through imaging in classic ultrasonography (3.5–10 MHz) up to imaging in micro ultrasonography (above 20 MHz).

Coded ultrasonography is intensively developed and studied in the last decade. The reason of such interest lies in the properties of the coded transmission: increasing of penetration depth, signal-to-noise ratio improvement, exploring the signal with lower amplitude and improving of the axial resolution moving to the higher frequency range. Nowadays extensively explored coded sequences are: linearly frequency modulated signals (chirp) and phase-modulated signals like Barker codes and Golay complementary sequences (side-lobe cancelling codes). Within the last few years, the increasing interest in visualization of tissue surface [1] as well as vessel wall research using high frequency ultrasound can be observed among biologists and clinicians. Development of high frequency ultrasound is directed to a new region of application in dermatology and diagnostics of the skin disease as well as lesion treatment [2–3].

The motivation of this work was to find a new transmission method of coded sequences based on complementary Golay sequences (CGS) to decrease a noise level in results RF echo signal and improve SNR in ultrasonic imaging. Coded sequences of shorts pulses based on CGS separated in time are transmitted in medium and received. This proposed method eventually can solve the problem connected to dead zone, that is actually important in ultrasonography, namely to examine and diagnose skin layers, cornea, iris, etc., because it allows to transmit the shorter codes. Double transmission of shorter codes instead the longer ones can also allow to obtain the higher SNR.

2. Double pulse transmission method

Among the different excitation sequences proposed in ultrasonography, Golay codes evoke more and more interest in comparison to other signals. The reason of that lies in the fact that Golay codes, like no other signals, suppress to zero the amplitude of side-lobes in ideal case. This type of complementary sequences has been introduced by GOLAY [4]. Practical implementation of complementary Golay sequences (CGS) is not widely available in the literature, for the convenience of the reader a step-by-step principle of construction and properties of the CGS as well as correlation principle are described in [5].

Figure 1 shows the double pulse transmission method using the Golay complementary sequences. As can be easily seen in practice even for coded transmission the different artifacts are present and because of that the noise elimination and efficient side-lobe cancellation cannot be obtained. And the noise level can lead to wrong visualization of the examined organs and range ambiguity. The nice method, which can decrease the noise level is using the longer Golay coded sequences i.e. 128 or even 512 bit lengths. Using longer coded sequences is welcome in radar technique or hydrolocation – where information located closely to transducer is not important. In ultrasonography the usage of longer coded sequences is rather limited since it leads to increase of the dead zone that is not accepted in some diagnostic application.

The area closely connected to transducer surface is called dead zone where the multiple reflections have very high amplitude and mask real echoes. The multiple reflections

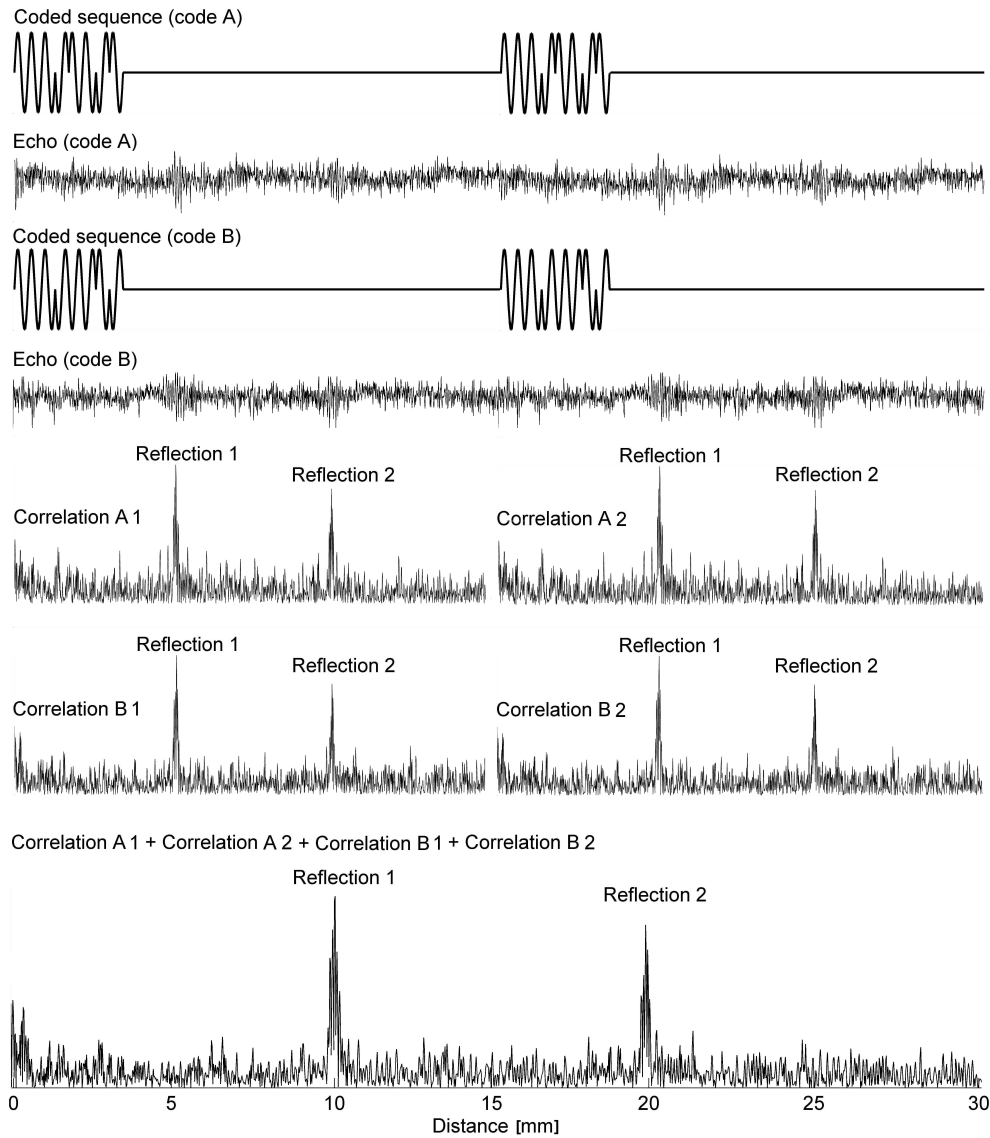

Fig. 1. Double pulse transmission method using Golay complementary sequences.

occur in the cupolas of the mechanical heads and on the interface transducer-skin. Theoretically, the dead zone area is equal to the half burst pulse time duration. But in practice the time duration of the burst pulse is calculated from the beginning to moment when the power drops to the -3 dB level, so the dead zone area is assumed to be equal to burst pulse time duration.

Increase of the echo detection using Golay complementary sequences in comparison to short pulse is evident. Previously reported experiments show the two echoes received

from reflectors distanced one from other by 1 cm. SNR improvement in compressed signal in comparison to direct echoes is about 15 dB [6].

The idea of double transmission method lies in an assumption of mutual noise cancellation, where noise in the resulted RF signal is averaged by summing two compressed echo signals obtained by single transmissions. Such solving allows to obtain the relatively high SNR using shorter coded Golay sequences that allows to increase SNR meaning the dead zone that is important in ultrasonography where grow interest in dermatology, ophthalmology, oncology etc., where dead zone plays an important role.

Figure 2 shows the comparison of transmitting 32-bits Golay coded sequences at nominal frequency 3.7 MHz and time duration 8.64 μ s and proposed method of the double transmission of 16-bits Golay coded sequences with shorter time duration that is equal 4.32 μ s. The start time of the second sequence depends on penetration depth that is examined. In the given case, the plot illustrates the examined environment on penetration depth up to 4 cm. The starting time of the second sequence can be calculated from:

$$t = \frac{2d}{c} = 50 \mu s,$$

where d is the depth, and c is the speed of the ultrasound wave in examined environment and is equal 1540 m/s.

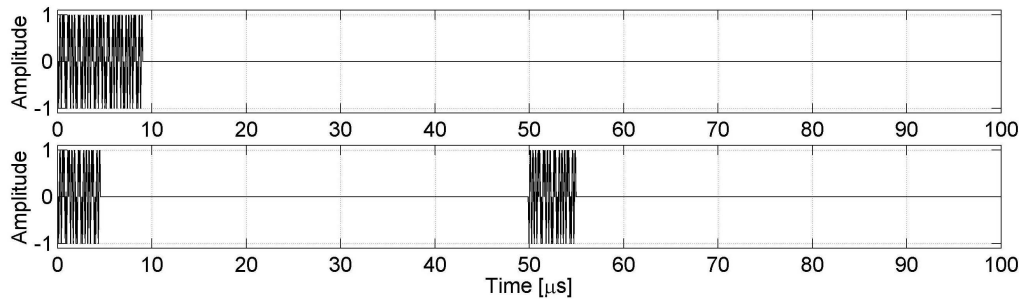

Fig. 2. Transmission of the 32-bits Golay sequence with time duration 8.64 μ s (top) and double transmission of the 16-bits Golay sequence with time duration 4.32 μ s (bottom).

In the second case the RF echo signals split into two sequences, next compressed and summed. The amplitude of main-lobe in the resulted compressed signal will be equal to 64 for both cases. This is because for single 32-bits coded transmission two RF echo lines are added, whereas in the case of double 16-bits coded transmission four RF echo lines need to be summed.

3. Experimental setup

The block diagram of the measurement arrangement used is shown in Fig. 3.

The Golay sequences with different lengths 8-, 16-, 32- and 64-bits at frequencies 3.7 MHz were synthesized in the following way. The Signal Generator HP8643A pro-

duced sine wave at 0 dB level at a given frequency. This signal was fed to the bipolar modulator driven by the $-1, 1$ sequences from the custom-designed coder. The coder circuitry based on the programmed logic EPM7064 allowed generating switched pair of single 64-bits Golay sequences and combined sequences of other shorter Golay codes separated in time as well as single coded sequences transmitted for later comparison. The coded signals were then amplified via the power RF amplifier ENI 3100LA and the transmitted coded burst excited the ultrasonic transducer scanned the tissue phantom *model 525 Danish Phantom Design*. The uncompressed RF echoes data were acquired using a digital storage 12-bits oscilloscope Infinium HP 54810A with a sampling rate of 100 MHz. All processing and display were done on the computer using Matlab[®] routines. The processing included amplification, pulse compression and summed for Golay sequences, envelope detection and the obtained results were in few seconds displayed on the monitors.

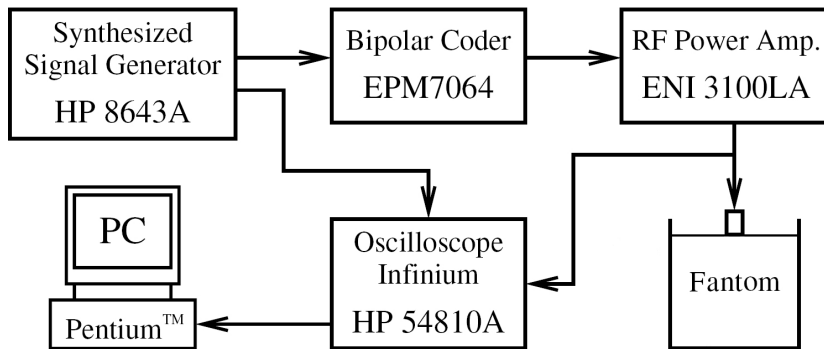

Fig. 3. Diagram of experimental setup.

4. Experimental results and discussion

The tissue phantom *model 525 Danish Phantom Design* with attenuation of background material $0.5 \text{ dB} \times \text{cm} \times \text{MHz}$ was used in the experiments.

The pair of the Golay sequences of the different lengths 8-, 16-, 32-, and 64-bits at the frequency 3.7 MHz were used. The centre RF echo lines obtained from the tissue phantom using the CGS of the different lengths transmitted by the two methods and calculated SNR are presented in the Figs. 4–7. The target reflections are the nylon filaments 0.1 mm in diameter spaced 1 cm one from another.

Figures 4–7 show the advantages of the double transmission of Golay coded sequences over single transmission used heretofore. In double transmission case the SNR increase by about 5.7 dB in comparison to the single transmission of the same length coded sequences and by about 4 dB in comparison to the single transmission of the two times longer sequences. According to TROTS *et al.* [5] in order to obtain the 4 dB SNR improvement the coded sequence needs to be about 16 times longer in the single transmission method. But using longer coded sequences results in increasing of the dead

zone area that increases proportionally to the coded sequences length and inversely to frequency. In case of 8-bits Golay sequences the dead zone area is equal to 1.66 mm (Fig. 4) and increases up to 13.3 mm for 64-bits Golay coded sequences (Fig. 7) for the frequency 3.7 MHz.

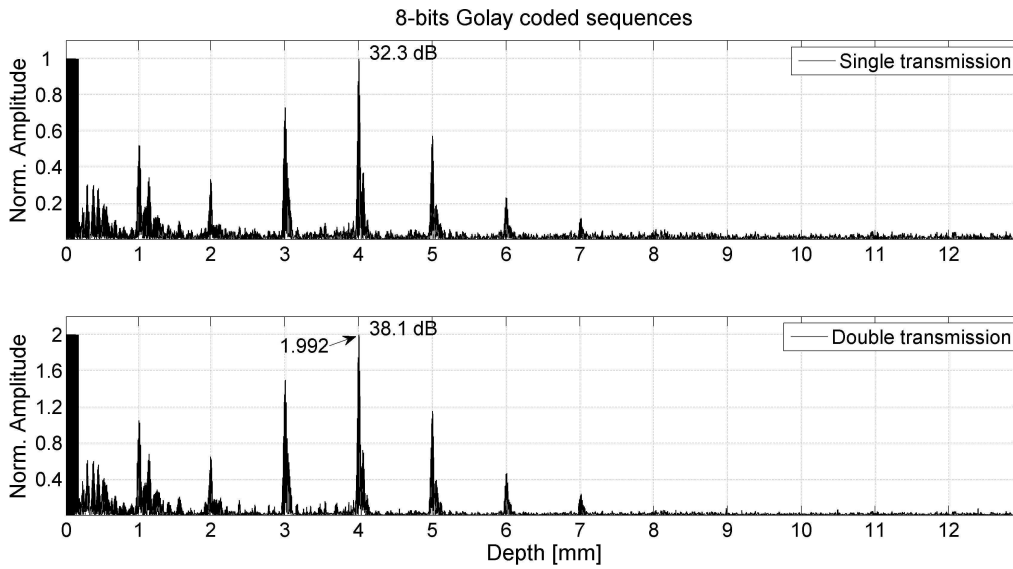

Fig. 4. The centre RF-lines of the tissue phantom obtained by single transmission (top) and double transmission (bottom) of 8-bits Golay sequences.

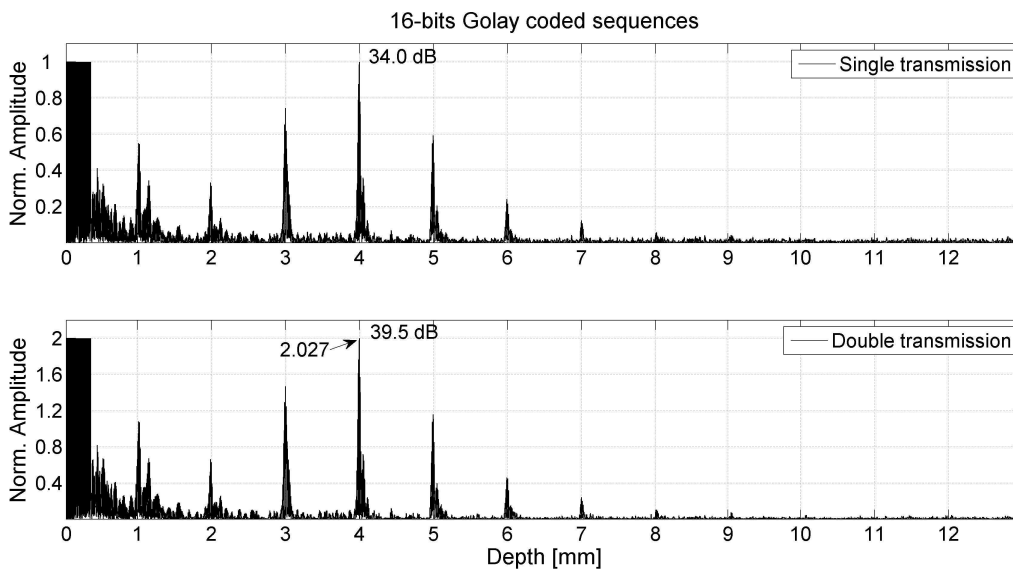

Fig. 5. The centre RF-lines of the tissue phantom obtained by single transmission (top) and double transmission (bottom) of 16-bits Golay sequences.

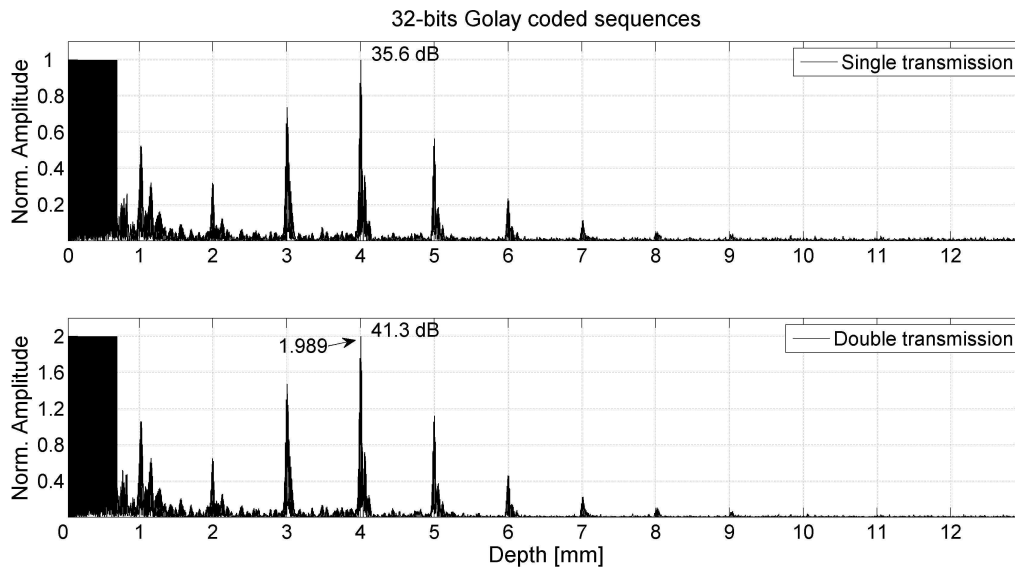

Fig. 6. The centre RF-lines of the tissue phantom obtained by single transmission (top) and double transmission (bottom) of 32-bits Golay sequences.

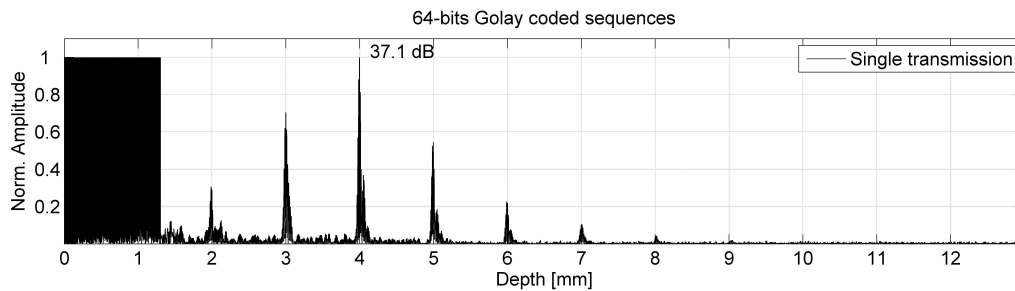

Fig. 7. The centre RF-lines of the tissue phantom obtained by single transmission of 64-bits Golay sequences.

The comparison of the obtained 2D ultrasonic images of a tissue phantom using 8-bits, 16-bits, 32-bits and 64-bits length Golay sequences transmitted by different methods are shown in Fig. 8. These recordings allow to verify axial resolution and the scan geometry. It consists of several nylon filaments twists 0.1 mm in diameter positioned every $1 \pm 2\%$ cm axially. Additional groups of 11 twisted threads for 6 dB axial and lateral resolution are placed at the different depths from top of the phantom. Also some groups of low contrast cylinders that deviates +3 dB, -3 dB and -6 dB from the background are placed.

The images in Fig. 8 demonstrate that the ultrasound imaging can benefit from double transmission of Golay sequences yielding a higher SNR and therefore a higher contrast resolution, while maintaining both axial and lateral resolution. The last resolution depends on transducer acoustic field and is discussed by NOWICKI *et al.* [7]. Also, it

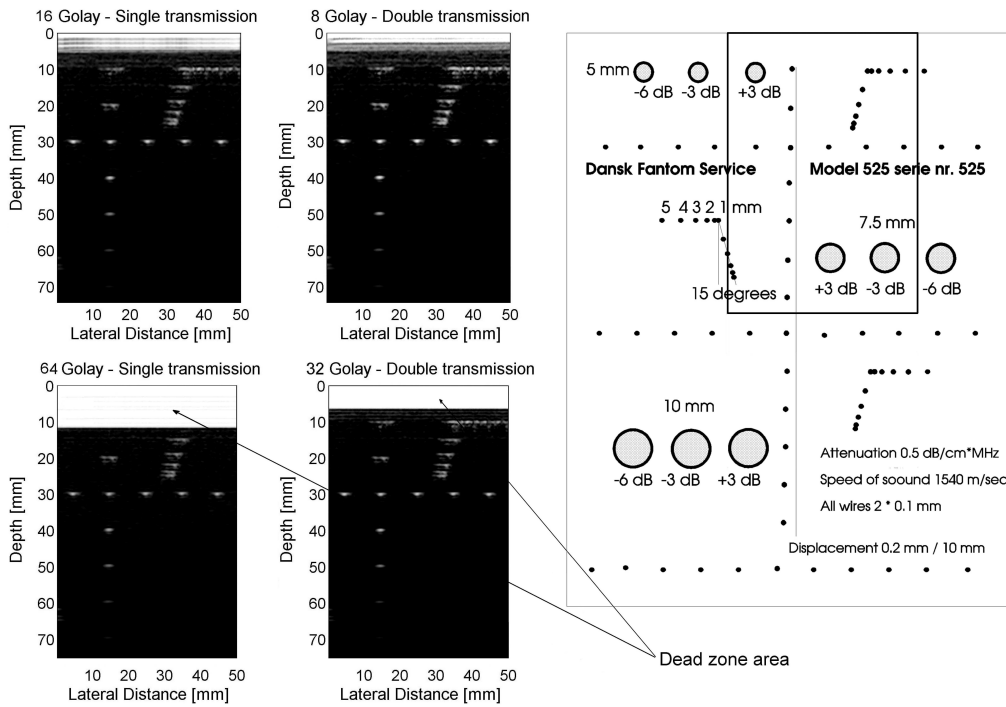

Fig. 8. Comparison of 2D ultrasonic images of the tissue phantom obtained using 8-bits, 16-bits, 32-bits and 64-bits length Golay coded used single transmission and double transmission. Schematic diagram of the examined tissue phantom *model 525*. The rectangle marks the scanned area.

needs to be noted, that in case of double transmission method in comparison to single transmission one the code length is two times shorter.

Obtained 2D ultrasonic images clearly demonstrate the advantage of double pulse transmission. As was mentioned above, increasing coded length leads to elongated dead zone area and in the case of 8-bits Golay sequences this area is equal to 1.66 mm while in the case of 64-bits Golay code the dead zone increases up to 13.3 mm. The dead zone area on the top of each 2D ultrasound image is created by high intensity echo amplitude, multiple reflections and is equal to the transmitted code length. In this area the real echoes are masked and using the longer codes lead to limited application in dermatology, where superficial structures are needed to be readable.

5. Conclusion

This paper discusses actual study and development trend of the coded transmission method in ultrasonography. One of the important parameters in ultrasound diagnostic is dead zone area that makes the real echoes lying closely to transducer surface unreadable. For that reason using of the coded sequences in ultrasound imaging is considerably limited!

The proposed work concerns the development and investigation of a new composing method of short coded sequences and their transmission based on well-known Golay complementary codes. This method allows to increase field of ultrasound diagnostic application where dead zone plays important role, e.g. dermatology, ophthalmology, etc.

The results obtained show the effectiveness of the double transmission and its resistance to the refraction, attenuation, and reflection of ultrasound waves. The SNR gain is evident when applying double pulse transmission method in comparison to single pulse transmission. Also, increasing codes length, the SNR increases and penetration elongates proportionally.

The proposed coded method of double transmission can be applied also in standard ultrasonography. Introduction of double coded transmission method in medical ultrasound equipment can increase the effectiveness and quality of the ultrasound diagnostic.

Acknowledgment

This work was supported by the Polish Ministry of Science and Higher Education (Grant N51804432/3434).

References

- [1] ALTMAYER P., EL-GAMMAL S., HOFFMANN K., *Ultrasound in dermatology*, Springer-Verlag, Berlin 1992.
- [2] KIELBASA Z., GAWDA H., WACH B., *Ultrasonography as a method of diagnosis and treatment monitoring in dermatology*, **LXII**, 1, 46, 242–247, Annales Universitatis Mariae Curie-Sklodowska, Lublin – Polonia, 2007.
- [3] SCHMID–WENDTNER M.-H., BURGDORF W., *Ultrasound scanning in dermatology*, Arch. Dermatol., **141**, 217–224 (2005).
- [4] GOLAY M.J.R., *Complementary series*, IRE Trans. Inf. Theory, IT-7, 82–87 (1961).
- [5] TROTS I., NOWICKI A., SECOMSKI W., LITNIEWSKI J., *Golay sequences – side-lobe – canceling codes for ultrasonography*, Archives of Acoustics, **29**, 1, 87–97 (2004).
- [6] NOWICKI A., SECOMSKI W., TROTS I., LITNIEWSKI J., *Extending penetration depth using coded ultrasonography*, Bulletin of the Polish Academy of Sciences Technical Scien., **52**, 3 (2004).
- [7] NOWICKI A., KLIMONDA Z., LEWANDOWSKI M., LITNIEWSKI J., LEWIN P.A., TROTS I., *Direct and post-compressed sound fields for different coded excitations*, Acoustical Imaging, **28**, 399–407 (2007).