

Synthetic transmit aperture method in medical ultrasonic imaging

Ihor Trots, Andrzej Nowicki and Marcin Lewandowski

Abstract—The work describes the use of a synthetic transmit aperture (STA) with a single element transmitting and all elements receiving in medical ultrasound imaging. STA technique is a novel approach to today's commercial systems, where an image is acquired sequentially one image line at a time that puts a strict limit on the frame rate and the amount of data needed for high image quality. The STA imaging allows to acquire data simultaneously from all directions over a number of emissions, and the full image can be reconstructed.

In experiments a 32-element linear transducer array with 0.48 mm inter-element spacing was used. Single element transmission aperture was used to generate a spherical wave covering the full image region. The 2D ultrasound images of wire phantom are presented obtained using the STA and commercial ultrasound scanner Antares to demonstrate the benefits of the SA imaging.

Keywords— Ultrasound imaging, synthetic aperture, frame rate, beamforming.

I. INTRODUCTION

MEDICAL ultrasound imaging is a technique that has become much more prevalent than other medical imaging techniques since this technique is more accessible, less expensive, safe, simpler to use and produces images in real-time. However, images produced by an ultrasound imaging system, must be of sufficient quality to provide accurate clinical interpretation. The most commonly used image quality measures are spatial resolution, image contrast and frame rate. The spatial resolution of the an ultrasound image can be improved by using several transmit beams focused at a different depth during the interrogation of each sector. It is done in modern ultrasound imaging systems at the cost of decreasing the frame rate, proportionally to the number of transmit foci [1]. An alternative way to obtain an appropriate spatial resolution, without decreasing of the frame rate, is to use the synthetic aperture technique.

Synthetic aperture has previously not been used in medical imaging. The basic idea of the SA method is to combine information from emissions close to each other. The idea, first described in [2], was to transmit an unfocused wave from one element and to use dynamic focusing only when receiving for

Authors are with the Institute of Fundamental Technological Research, Polish Academy of Sciences, Pawinskiego 5B, 02-106 Warsaw, Poland (corresponding author to provide phone: +48 22 826 12 81 ext.314; e-mail: igortr@ippt.gov.pl).

This work was supported by the Polish Ministry of Science and Higher Education (Grant NN518418436).

all points the wave passed. This is a contrast to the conventional beamforming, where only imaging along one line in receiving is used. In the SA method every image line is imaged as many times as the number of elements used. This will create an equal amount of low resolution images which are summed up to create one high resolution image.

There are some different beamforming methods. In a classical Synthetic Aperture Focusing Technique (SAFT), only a single array element transmits and receives at each time. It reduces the system complexity and the frame rate, but requires data memory for all data recordings [3]. The main disadvantage of SAFT is the low signal-to-noise ratio (SNR) and as a result, the poor contrast resolution. In a Multielement Synthetic Aperture Focusing (MSAF) method, at each time a group of elements transmits and receives signals simultaneously [4]. The transmit beam is defocused to emulate a spherical wave. The SNR is increased compared to SAFT, in which only a single element is used in transmit and receive.

In this paper, the Synthetic Transmit Aperture (STA) method for medical ultrasound imaging system is described. In this method, at each time one array element transmits a pulse, and all elements receive the echo signals [5]. Compared to other beamforming methods, the advantage of this approach is that a full dynamic focusing can be applied to the transmit and the receive, producing the highest quality of images while maintaining or even drastically decreasing the time of image acquisition which allows to increase frame rate.

II. SYNTHETIC TRANSMIT APERTURE BEAMFORMING

One of the important processes in ultrasound imaging systems is beamforming. In the STA method at each time one array element transmits a pulse and all elements receive the echo signals. Here data are acquired simultaneously from all directions over a number of emissions, and a full image can be reconstructed from this data, Fig.1.

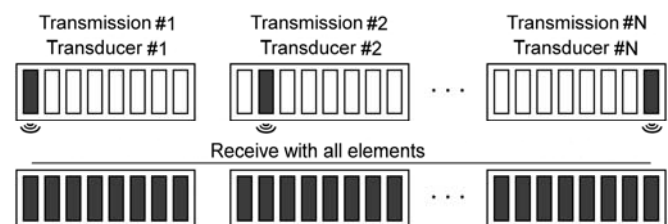

Fig. 1 Transmitting and receiving in STA method

In the STA method focusing is performed by finding the geometric distance from the transmitting element to the imaging point and back to the receiving element. The structure of the synthetic aperture and the geometric relation between the transmit and receive element combination and the focal point is shown in Fig. 2.

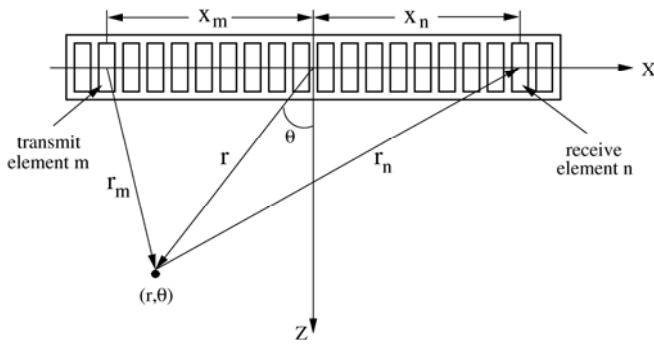

Fig. 2 Geometric relation between the transmit and receive element combination and the focal point

When a short pulse is transmitted by element m and the echo signal is received by element n , as shown in Fig. 2, a round-trip delay is

$$\tau_{m,n} = \tau_m + \tau_n \quad (1)$$

where (m, n) is a transmit and receive element combination, $0 \leq m, n \leq N-1$.

The delays for m 'th element and n 'th element are

$$\tau_m = \frac{1}{c} \sqrt{x_m^2 + r^2 - 2x_m r \sin \theta} \quad (2)$$

$$\tau_n = \frac{1}{c} \sqrt{x_n^2 + r^2 - 2x_n r \sin \theta}$$

where x_m, x_n are the positions of the m 'th and n 'th elements, respectively and r is the distance between the synthetic aperture centre and the point (r, θ) .

For an N -element array for each point in an image, the A-scan signal can be expressed as

$$A(r, \theta) = \sum_{m=0}^{N-1} \sum_{n=0}^{N-1} y_{m,n}(t - \tau_{m,n}) \quad (3)$$

where $y_{m,n}(t)$ is the echo signal and $\tau_{m,n}$ is beamforming delay for the (m, n) receive and transmit element combination given in (1). The first and the second summations correspond to transmit and receive beamforming.

III. COMPUTER SIMULATION

Simulation is a fundamental way of testing methods. This is done to confirm or reject an hypothesis in a controlled

environment. Since it is possible to control all parameters in a simulation, one can set up a simple model and then gradually transform it into something more similar to reality. Once this is done one can continue with measurements and confirm or reject the simulations for a real setup, in vivo or on a phantom. All simulations in this work are carried out in a powerful software, *Field II* (a powerful simulation program, developed by Jørgen Arendt Jensen). The program is developed especially for investigating ultrasound fields, and gives the possibility to simulate and calculate ultrasound fields and defining one's own transducer. The accuracy is very high since *Field II* is based on numerical analysis and thus not restricted by any approximations when calculating fields. *Field II* runs under Matlab which makes it even more versatile and useful. This is the reason why *Field II* is used worldwide.

To simulate a measurement numerous parameters have to be set. The transducer used in the measurements described later is the linear transducer LA510 from Echoson. The parameters used in the simulations are set to be similar to those of transducer. The medium in the simulations is homogenous and its only variable parameter is the speed of sound. In the simulations no attenuation is considered. Even so, echoes far from the transducer become weaker and have a lower amplitude because the energy is spread out. These simplifications do not affect the method in principle and in measurements these simplifications have been taken into consideration.

Obtained by computer simulation 2D ultrasound image of phantom for 32-element linear transducer array with 0.48 mm inter-element spacing and one-cycle burst pulse at nominal frequency 5 MHz is shown in Fig. 3. The phantom medium is without any attenuation and consists of a collection of point targets to imitate the measurements.

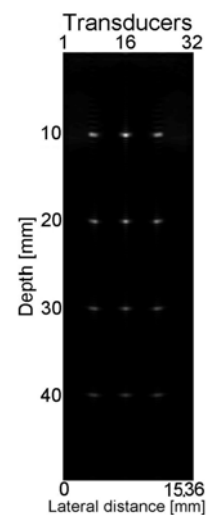

Fig. 3 2D ultrasound phantom image with point targets

Simulation shows that axial and lateral resolutions are the same in the whole examined medium beginning from the area near transducer and down to 40 mm.

IV. ULTRASOUND IMAGING SYSTEM

A simplified ultrasound imaging system is shown in Fig. 4.

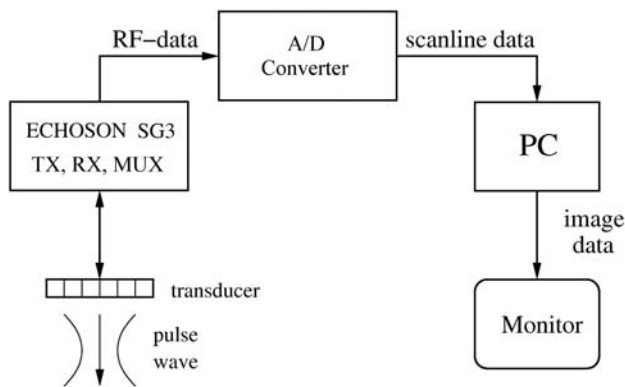

Fig. 4 Block diagram of an ultrasound imaging system

Transducer transmits pulses of the ultrasound waves, and receives reflected echo signals. Echoston SG3 enables full control of selected 32 consecutive transducers of a linear array. Parameters of transmission and reception are programmable from a PC using a serial port (RS-232). Using the SG3 one can switch on arbitrary transmit and receive channels in the selected 32 channels aperture. The second block, A/D converter extracts the RF data, acquires it and send to the PC. Next, the collected digital data are processed offline and displayed on the monitor. All post processing and display is done on the computer using Matlab. The processing creates 2D ultrasound image focused in every point.

The system allows to perform simulated multichannel acquisition for synthetic aperture imaging. Using a single channel digitizer and switching receiving transducers the system is capable of gathering RF data for up to 32 lines. Repeating this procedure for each of the 32 TX transducers the 32×32 data recordings needed for image reconstruction are obtained and are the input to the synthetic aperture algorithm.

Synthetic aperture image reconstruction requires a huge amount of data storage and processing power. In synthetic aperture processing all scan lines (full image) are created in each and every firing, where in standard beamforming only single line is created. The amount of raw RF data needed in STA imaging for reconstruction of a single image is proportional to $D_{RF} * N^2$ and the number of delay-and-sum operations is $D_{RF} * N^3$, where D_{RF} is the number of samples in a single RF line.

V. EXPERIMENTAL RESULTS AND DISCUSSION

The 32-element linear transducer array with 0.48 mm inter-element spacing and a burst pulse with time duration 100 ns (a half-cycle at nominal frequency 5 MHz) were used. The inter-element space is about 1.5λ . All elements are used for both transmitting and receiving. One single element in the transducer transmitting aperture was used to generate a

spherical wave covering the full image region. Each time only one element transmits the probing signal and all elements receive the echoes. The transmit and receive elements combination gives a total of 32×32 possible RF A-lines. All these possible A-lines echo signals were sampled independently at 50 MHz and stored.

The multi wire phantom, used in the experiments, consisted of 24 wires 0.1 mm in diameter positioned every 2 mm axially and at an angle of 75 degrees. This phantom allows to examine the axial and lateral resolution at various depths in the ultrasound image as well as focal and dead zone registration. This multi wire phantom surrounded by water allows to obtain high amplitude echo signals from the wires because there was almost no attenuation.

Three of 1024 (32×32) received RF echo signals which were digitized and stored in the PC are shown in Fig. 5.

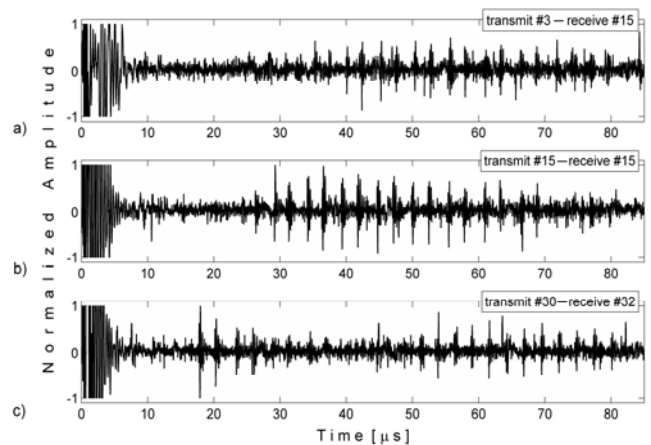

Fig. 5 The recorded by PC RF echo signals: a) element #3 is transmitting – element #15 is receiving, b) #15 transmitting – #15 receiving, c) #30 transmitting – #32 receiving

All these RF echo signals are different and echo time position and signal amplitude in every case depends on sound field and geometrical position of transmitted and received transducers. After all emissions the full set of the RF A-lines echo signals needed to reconstruct one 2D B-mode ultrasound image is obtained. For this aim the RF lines are input to the synthetic aperture algorithm which calculates the time delay for every imaging point.

As was mentioned above, a single element in the transducer aperture is used for transmitting a spherical wave covering the full image region. The received signals for all or part of the elements in the aperture are sampled for each transmission. This data can be used for making a low resolution images (Fig. 6a – 6c), which is only focused in receive due to the unfocused transmission. Focusing is performed by compensating the geometric distance from the transmitting element to the imaging point and back to the receiving element and can be obtained from (3). These low resolution images need to be added coherently to form the final high resolution image (Fig. 6d).

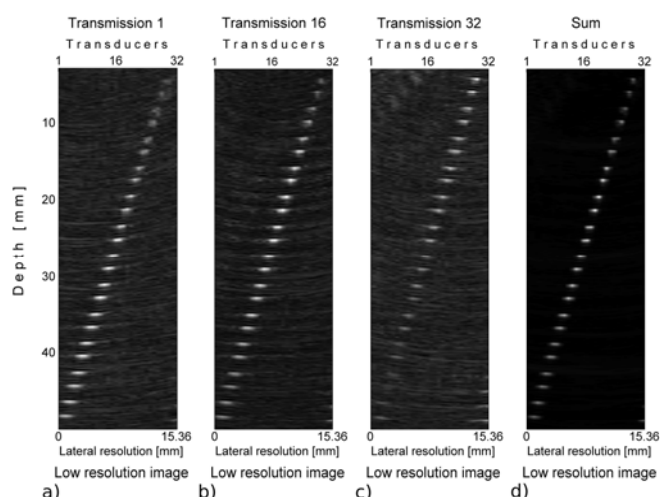

Fig. 6 Low resolution images combined to produce a high resolution image. One element transmit at the time, while all are used to receive. The images is then added into one high resolution image

The comparison of the reconstructed wire phantom images obtained using STA method and standard linear array scanning with commercial ultrasound scanner Antares (Siemens, Mountain View, CA, USA) is shown in Fig. 7. The 128-elements linear transducer array with 0.3 mm pitch (VF13-5) and a burst cycle pulse at nominal frequency 10 MHz were used in scanner.

The maximum quantity of focal points, which were equal to 1 and 8, were chosen in the ultrasound scanner, they are marked by triangles in the bar. It needs to be noted, that frame rate in the case of 8 focal points dramatically decreases down to 4 fps (in the case of one focal point it is equal to 31 fps). Such frame rate is definitely insufficient to normal examine the dynamically moving organs, such as heart, where high frame rate even up to 50 fps is requirement.

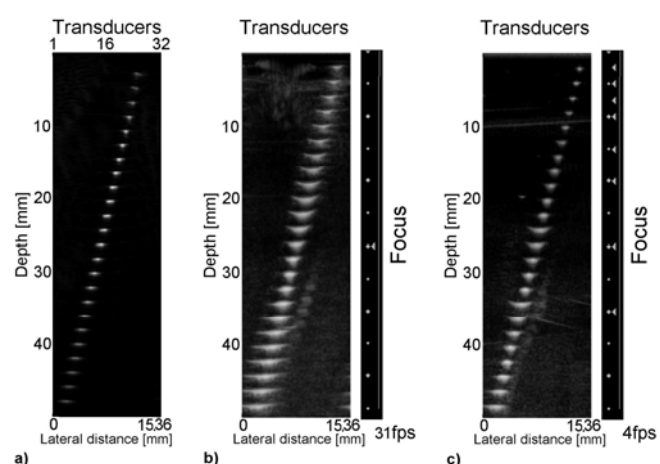

Fig. 7 2D ultrasound images of the wire phantom: a) using STA method; b) ANTARES ultrasound scanner with one focal point; c) ANTARES ultrasound scanner with 8 focal points

In Fig. 7c it can be easily seen, that axial and lateral resolutions at the top and at the bottom parts of the image are different and depend on the focal point quantity in these regions [6].

Fig. 7 shows that the STA method allows to obtain good resolution in all explored region maintaining the frame rate high. The results show the effectiveness of the STA method and its resistance to the refraction, attenuation, and reflection of ultrasound waves.

VI. CONCLUSION

The work concerns the development and investigation of the STA method that allows to increase system frame rate and thus improve the image quality. The paper has given example of how medical SA ultrasound imaging can be acquired and processed. The STA method was investigated both by simulation and experimentally. The phantoms, which contain wires, were used to test image quality in general.

The images reconstructed from the STA system give the same image resolution as that from the conventional ultrasound system, with an increased frame rate. The STA system offers higher image resolution than conventional system if the frame rate is the same. The disadvantage of the STA system is that storage and processing requirements are higher than in conventional beamforming, because the RF data must be stored for every combination of transmit and receive elements, and later recombined.

The synthetic aperture method can be applied in standard ultrasound scanner. Introduction of STA method in medical ultrasound increases the effectiveness and quality of the ultrasound diagnostic.

REFERENCES

- [1] S. Holm, H. Yao, "Method and apparatus for synthetic transmit aperture imaging," US patent No 5.951.479, September 14, 1999.
- [2] C. Passman, H. Ermert, "A 100 Mhz ultrasound imaging system for dermatologic and ophthalmologic diagnostics," *IEEE Trans. Ultrason. Ferroelec. Freq. Contr.*, Pusan, South Korea, vol. 43, no.4, pp. 545-552, 1996.
- [3] J. Ylitalo, "On the signal-to-noise ratio of a synthetic aperture ultrasound imaging method," *European J. Ultrasound*, Elsevier, Ireland, vol. 3, no.3, pp. 277-281, 1996.
- [4] M. Karaman, H. Bilge, M. O'Donnell, "Adaptive multi-element synthetic aperture imaging with motion and phase aberration correction," *IEEE Trans. Ultrason. Ferroelec. Freq. Contr.*, INIST-CNRS, vol. 45, no. 4, pp. 1077-1087, 1998.
- [5] J.A. Jensen, S.I. Nikolov, K.L. Gammelmark, M.H. Pedersen, "Synthetic Aperture Ultrasound Imaging," *Ultrasonics*, Elsevier, The Netherlands, vol. 44, no.1, pp. e5-e16, 2006.
- [6] A. Nowicki, Z. Klimonda, M. Lewandowski, J. Litniewski, P.A. Lewin, I. Trots, "Direct and post-compressed sound fields for different coded excitation," *Acoustical Imaging*, vol. 28, pp. 399-407, 2007.