

Semi-active damping of vibrations. Prestress Accumulation-Release strategy development

A. Mroz*, A. Orłowska and J. Holnicki-Szulc

Polish Academy of Sciences, Institute of Fundamental Technological Research, Smart Technology Centre, ul. Pawinskiego 5B, 02-106 Warszawa, Poland

Received 19 August 2007

Abstract. New method for semi-active control of vibrating structures is introduced. So-called Prestress Accumulation-Release (PAR) strategy aims at releasing of the strain energy accumulated in the structure during its deformation process. The strain energy is converted into kinetic energy of higher modes of vibration which is suppressed with structural damping or by means of a damping device. The adaptation process essentially affects the first mode vibrations by introducing an elastic force that opposes the movement. Numerical simulations as well as experimental results prove that the strategy can be very effective in mitigating of the fundamental mode of a free – vibrating structure. In a numerical example 95% of the vibration amplitude was mitigated after two cycles. An experimental demonstrator shows 85% reduction of the amplitude in a cantilever free- vibrations. In much more complex practical problems smaller portion of total energy can be released from the system in each cycle, nevertheless the strategy could be applied to mitigate the vibrations of, for example, pipeline systems or pedestrian walkways.

Keywords: Semi-active control, adaptive structures, free-vibrations, bang-bang control

1. Introduction

The problem of damping of vibration in engineering structures has been investigated for many years. Since many new, adaptive technologies are commercially available, a number of recent studies have been focused on active and semi-active techniques. A great number of literature references is available on semi-active methods, among which [5, 12] give interesting examples of use of the magnetorheological fluid and piezoelectric devices, respectively. Semi – active methods are popular, because of their high efficiency and relatively low cost compared to passive and active damping of vibrations [8,13]. Some interesting investigations of semi-active techniques have also been published in [2,3,6].

Prestress Accumulation-Release (PAR) belongs to the class of on-off, semi active solutions. It is a method to convert the strain energy of a vibrating system into kinetic energy, which is then released from the system by means of the structural damping or a dissipative device. The method described in this paper is a semi-active technique which means that it does not require a supply of a substantial amount of energy.

The first formulation of the PAR concept for a mass-spring system and a double layered cantilever beam was presented in [4,11]. A similar concept is investigated in [9], where a mass-two-spring system vibrations are suppressed due to a controlled detaching and reattaching of a spring, whereas [10] deals with the use of on-off joint connections control for energy dissipation in a flexible truss-beam structure. The present paper alike works [9,10] are examples of an on-off, or ‘bang-bang’ class of control strategies, where the actuator can assume only two states.

The dissipating process discussed in the present paper consists of two phases. In the first phase some kinematic constraints imposed on the system are released at the instant when the maximum strain energy can be converted to

*Corresponding author. Tel.: +48 22 751 66 82; Fax: +48 22 751 66 83; E-mail: amroz@ippt.gov.pl.

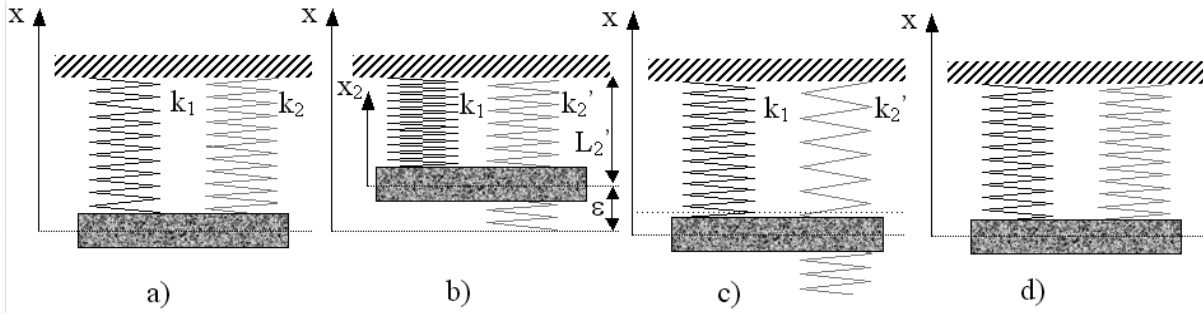

Fig. 1. Mass – two-springs system.

the kinetic energy. It is usually manifested with local, higher frequency vibrations. In the second phase kinematic constraints are reimposed, which leads to the conversion of a part of the kinetic energy into another, non-mechanical form, for example heating-up of the actuator device. The process of imposing constraints results in applying an elastic force that opposes the further movement of the system.

First, the proposed approach is described theoretically on a simple spring – mass system in order to demonstrate the idea of response mitigation and to show the energy balance of the system.

Secondly the numerical studies are presented for a layered beam simulating a pedestrian bridge, where the control is based on disconnecting (for a very short instant of time) and then sticking back two layers (delamination effect).

Finally, the experimental results are presented. A laboratory-scale set-up was built to verify the effectiveness of the PAR strategy on a cantilever beam demonstrator. Controllable delamination effect was obtained by means of piezo-electric actuators. The control was carried out as a closed loop feed – back system.

2. Mass – spring system

2.1. The concept

A simple mass – two-springs system is considered as shown in Fig. 1a. One of the springs is active in the sense that it can be detached and then reattached to the mass anywhere along the spring length. During the free vibration of the system the active spring can be detached anytime, in particular at the time instant of the maximum displacement of the mass. As soon as the disconnected spring reaches its free length it is re-attached to the mass. (see Fig. 1b). As a consequence a force that opposes the mass motion is introduced in the following phase of vibration, proportional to the displacement of the active spring from its new equilibrium position. Thus, a new equilibrium of the whole system is established (dotted line in Fig. 1c). Detaching and attaching of the spring is realized by imposing and releasing kinematic constraints which generates transient vibrations. In particular the attaching process creates an impact followed by higher frequency, local vibrations. They are, however damped out by the structural damping which is much more intense for higher frequencies.

The procedure can be repeated several times. Once the satisfactory damping effect has been obtained the active spring can be detached/ reattached again which results in returning of the system to the initial configuration.

2.2. Analytical solution

2.2.1. Equation of motion

In this section the system shown in Fig. 1 is analyzed in detail. If the natural damping is not considered and no force excitation is used, then the motion in the first phase of vibration is governed by the equation:

$$m\ddot{x}(t) + (k_1 + k_2) \cdot x(t) = 0 \quad (1)$$

where m is the vibrating mass and $k_i = \frac{E_i \cdot A_i}{L_i}$ is the stiffness of a spring with a cross section A_i , Young's Modulus E_i and a free length L_i . The solution under the given initial conditions $x(t = 0) = -\varepsilon$, and $\dot{x}(t = 0) = 0$, takes the form:

$$x(t) = -\varepsilon \cdot \cos\left(\sqrt{\frac{k_1 + k_2}{m}}t\right) \quad (2)$$

At the time instant of maximum displacement, $t = t^1$ the active spring is detached and reattached as it comes to its equilibrium position (see. Fig. 1b). At this point it is assumed that the inertia of springs is not taken into account. Now the equation of motion is given by:

$$m\ddot{x}(t) + k_1 \cdot x(t) + k'_2 \cdot x_2(t) = 0 \quad (3)$$

where $k'_2 = \frac{E_2 \cdot A_2}{L'_2}$ with new active spring length $L'_2 = L_2 - \varepsilon$, and x_2 is the active spring displacement in the second phase: $x_2(t) = x(t) - \varepsilon$. The system has still a single degree of freedom, namely the displacement of the mass m . Equation (3) can be rewritten as:

$$m\ddot{x}(t) + (k_1 + k'_2) \cdot x(t) = k'_2 \cdot \varepsilon \quad (4)$$

It can be seen that in the second phase of the process, the governing equation is non-homogenous with a term $k'_2 \cdot \varepsilon$, which can be viewed as an additional, constant force applied to the system. Now the solution takes the form:

$$x(t) = C_1 \cdot \cos\left(\sqrt{\frac{k_1 + k'_2}{m}}t\right) + C_2 \cdot \sin\left(\sqrt{\frac{k_1 + k'_2}{m}}t\right) + \frac{k'_2 \cdot \varepsilon}{k_1 + k'_2} \quad (5)$$

with constants C_1 and C_2 calculated from initial conditions: $x(t = t^1) = \varepsilon$, and $\dot{x}(t = t^1) = 0$.

2.2.2. Energy balance

The potential energy of a spring is equal to the work of the elastic force done along the displacement direction:

$$E_{POT} = \int_0^{x_k} k_i \cdot x dx = \frac{1}{2} \cdot k_i \cdot x_k^2 \quad (6)$$

The total energy of the system in the instant before activation of the control ($t = t^1 - dt$) is:

$$E_{TOT} = \frac{1}{2}k_1 \cdot \varepsilon^2 + \frac{1}{2}k_2 \cdot \varepsilon^2 + 0 \quad (7)$$

The total energy of the system in the instant after activation of the control ($t = t^1 + dt$) is:

$$E_{TOT} = \frac{1}{2}k_1 \cdot \varepsilon^2 + \frac{1}{2}k'_2 \cdot (\varepsilon - \varepsilon)^2 + 0 = \frac{1}{2}k_1 \cdot \varepsilon^2 \quad (8)$$

The control is activated at the point of maximum displacement, where $\dot{x} = 0$, thus at this point the kinetic energy vanishes. Comparing Eqs (7) and (8) it can be observed that the total energy after activating the control is smaller by the term $\frac{1}{2}k_2 \cdot \varepsilon^2$. If the inertia of springs is not neglected then additional terms are introduced to keep track of the "missing" part in the energy balance. This situation is discussed in further sections.

2.2.3. Numerical example

Figure 2 depicts the resulting displacement of the mass if the following data were used for calculations:

- $m = 20$ kg
 - $L = 0.1$ m
 - $E = 6e10$ Pa
 - $A = 1.54e-8$ m²
 - $\varepsilon = 0.01$ m
- } both springs equal

A two-fold activating of the control has caused the vibrations to vanish almost completely. A slight change in frequency of the controlled response as compared with the reference case is due to a small change in the spring stiffness, which is caused by a change of the spring length. It can be observed that after activating of the control, the system oscillates about a new equilibrium position (see Fig. 2).

The time instant of activating the control corresponds to the maximum value of accumulated strain energy and, under the assumed simplifications results in an instant decrease of the strain energy (see Fig. 3, Eqs(7) and (8)). In a more practical approach a part of the energy would be transferred into higher frequency vibrations of the detached part of the active spring, and part would be dissipated in the process which is here idealized as imposing some kinematic constraints.

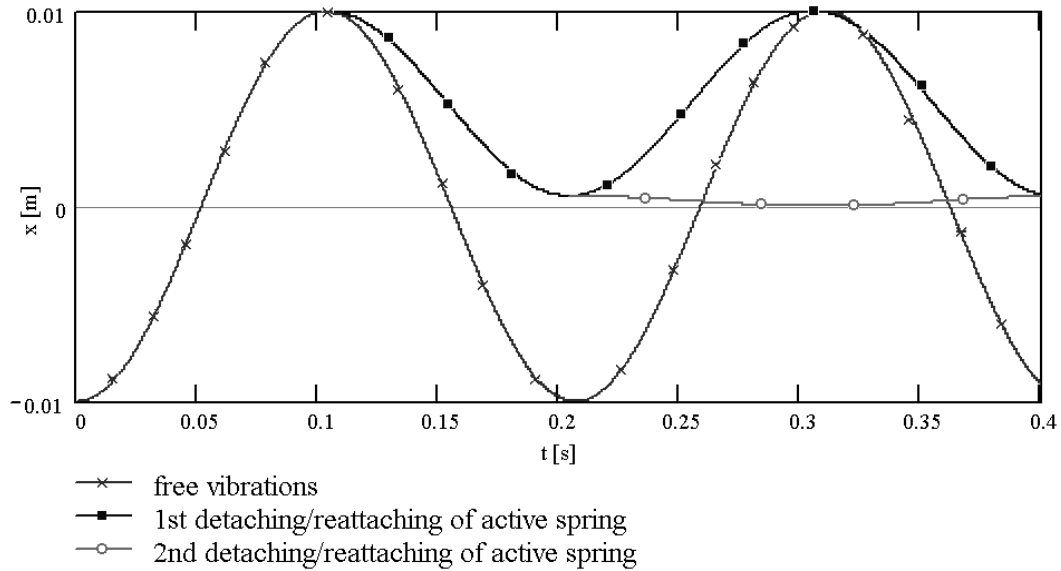

Fig. 2. Resulting mass displacement; control triggered twice.

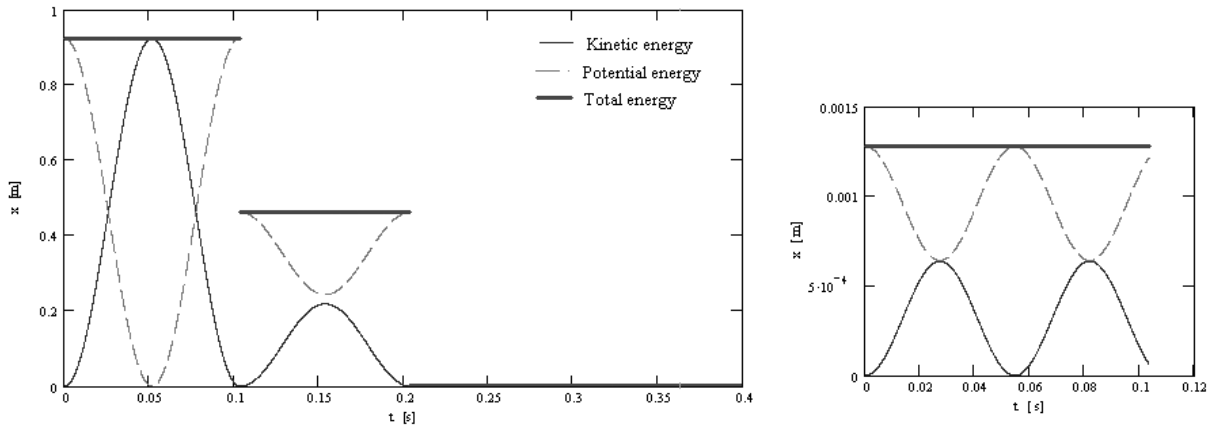

Fig. 3. Energy balance.

2.3. A case with the inertia of the active spring considered

2.3.1. Introduction

As stated before, detaching of the active spring results in converting the accumulated strain energy into kinetic energy, which can be dissipated from the system during reattachment of the spring. This whole process was idealized in the previous section by imposing proper initial conditions, which resulted in an instant decrease in energy of the system. In practice, part of the released strain energy is dissipated by a device that reattaches the spring and the remaining part introduces higher frequency vibrations which can be, however, easily suppressed with natural damping of the system.

In the present analysis, the control device is idealized with imposing/releasing of local constraints between the geometrical point of mass m and any point along the active spring. The mass of active spring is concentrated at its end and in the middle (see Fig. 4).

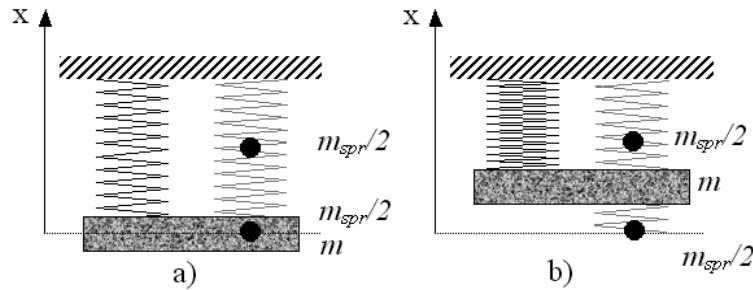

Fig. 4. Dynamic model with inertia of active spring included.

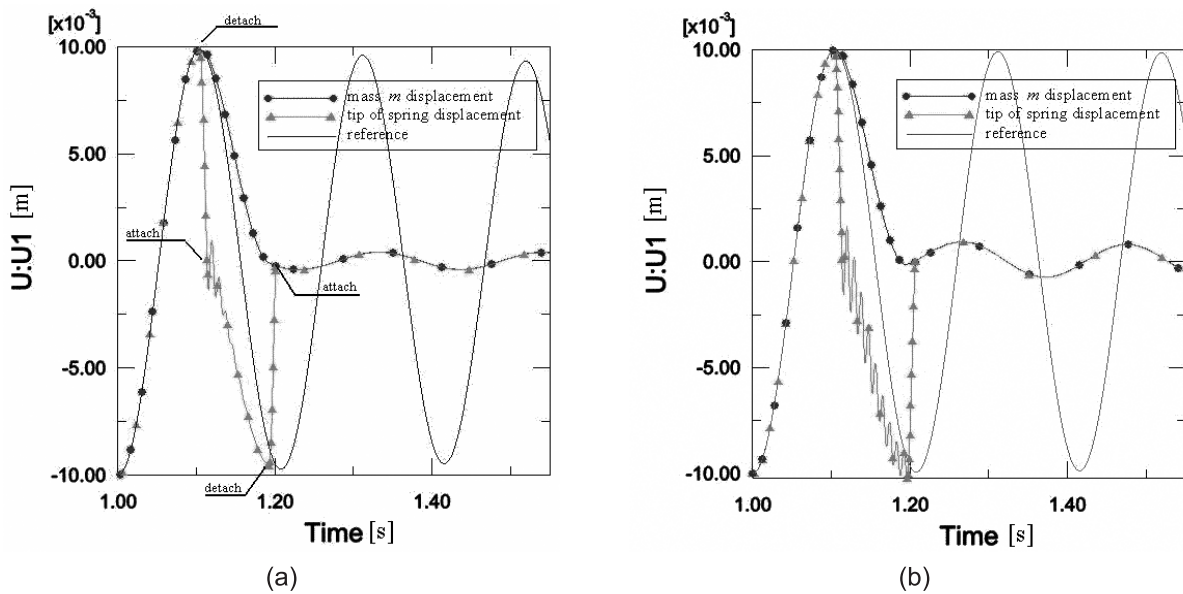

Fig. 5. Response of the system; a) 1% of critical damping b) 0.2% of critical damping.

Slight natural damping is also introduced into the equations. The Rayleigh damping coefficients introduce little damping (1% or 0.2%) around the first natural frequency and relatively much higher damping of higher frequencies. All remaining parameters do not change. Simulations were performed using Abaqus/Standard code.

2.3.2. Results

Displacements of mass m and the tip of the spring are depicted in Fig. 5. Detaching of the active spring and reattaching it at some point along its length introduces higher frequency vibrations of the spring loose end. Releasing/reimposing the constraint again results in returning of the system to the initial configuration, with the amplitude of the fundamental mode of vibrations decreased.

The whole procedure can be repeated several times, if needed. If, for instance, the active spring stiffness was considerably smaller than the passive one, then the desired mitigation effect would have to be obtained in more steps. In the analyzed example the control was activated twice, and the amplitude of mass m displacement was decreased by 96% and 92% for 1% and 0.2% of the critical damping, respectively. The procedure is very sensitive to the time instant of detaching the spring.

Re-imposing the constraints causes higher frequency vibrations of the mass located in the middle of the spring. These vibrations however are effectively damped out by the natural damping of the system. A typical behavior of the middle mass is shown in Fig. 6.

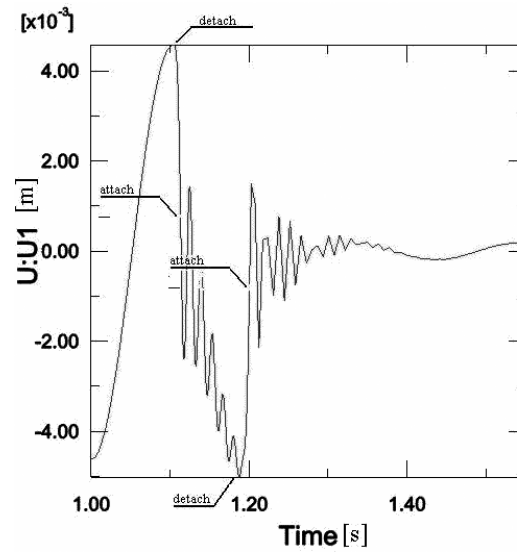

Fig. 6. Middle mass response with indicated points corresponding to activating control.

All non-zero forms of energy can be viewed in Fig. 7. Steep, exponential decline in the sum of potential and kinetic energy graph is due to the viscous dissipation which increases with the increase of vibration velocity. The highest vibration velocity follows the imposing/ releasing of the constraints. The viscous dissipation is due to the natural damping of the system.

3. Delamination of a layered beam

3.1. PAR strategy for layered beams

The strategy of releasing the accumulated strain energy in order to dissipate it can, in theory, be effectively used for various types of structures. If a layered beam is considered as shown in Fig. 8, the idea of adaptation would be as follows. First, at the point of maximum deflection two layers are disconnected resulting in the instant dislocation of layers (1' in Fig. 8a). The dislocation is “frozen” if the layers are reconnected. This yields introduction of an elastic force that opposes the further vibration of the structure (2 in Fig. 8a). Then, near the equilibrium position layers are disconnected/ reconnected again in order to return to the initial configuration. The whole sequence can be repeated until the desired effect is obtained.

A similar effect of response mitigation can be obtained if a truss structure is considered with a detachable element (see Fig. 8b). Applying the same methodology for control, the axial strain accumulated in an active element can be released as the element is disconnected at one of its ends.

It is worth mentioning that in both cases only one active member is required in order to mitigate the fundamental mode of vibration.

3.2. Numerical example – simply supported beam

3.2.1. Numerical model

A simply supported, two-layered beam with the span of 15.6 m is considered. Bending stiffness of each layer is $EI = 2.218 \times 10^6 \text{ Nm}^2$. Material damping of 1% of critical damping is assumed around the 1st natural frequency. Layers are permanently connected together at the left support. It is assumed that there is a device at the right support capable of instantly disconnecting or sticking the layers. Along the beam length the distance between layers remains

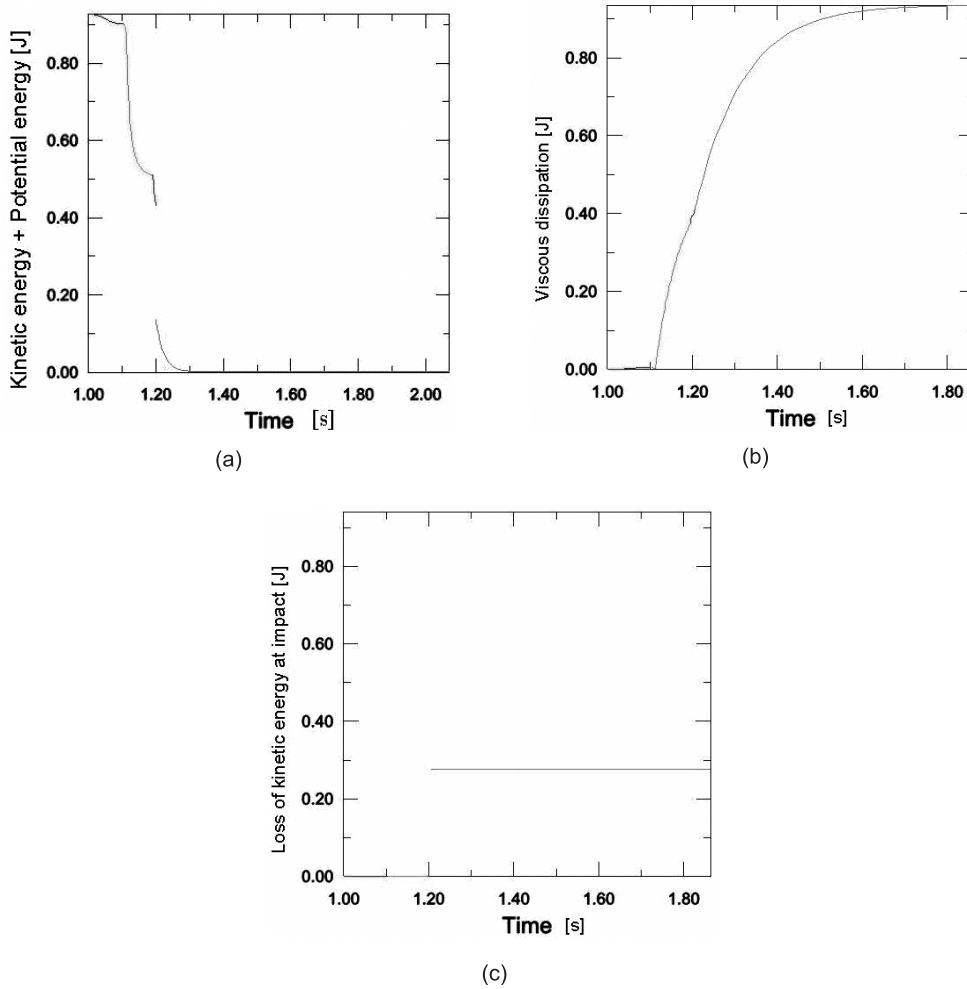

Fig. 7. a) sum of strain and kinetic energy b) viscous dissipation due to natural damping c) loss of kinetic energy during imposing constrains.

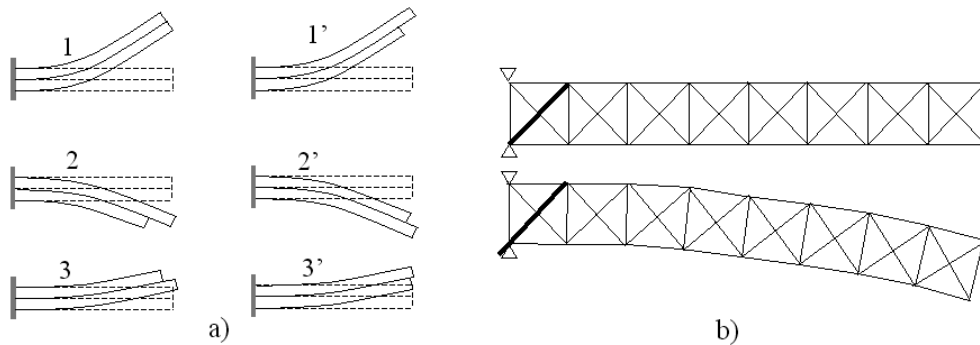

Fig. 8. PAR strategy for a cantilever beam.

the same, whereas the frictionless, relative movement of layers is possible in the direction parallel to the beam axis. Considered beam model is depicted in Fig. 9.

The numerical simulations were performed using Abaqus Standard code. Elastic layers were modeled with 3-node

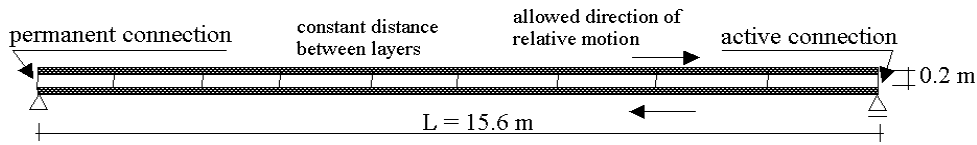

Fig. 9. Assumed model of layered beam.

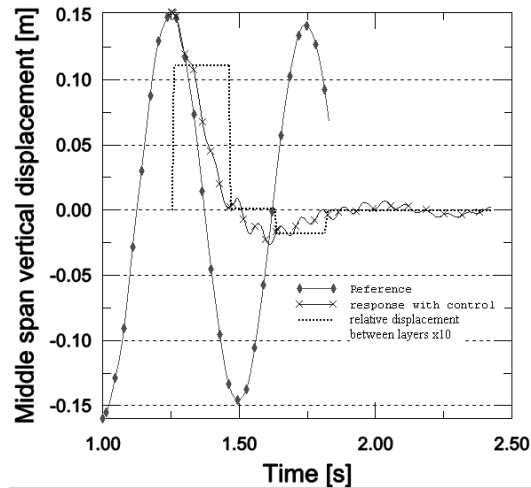

Fig. 10. Vertical displacement of the middle of beam.

quadratic beam elements. Constant distance between layers was obtained with Slot type connector elements spaced every 0.90 m. The layers' relative displacement was controlled by means of one active connector element located at one of the beam ends. The active connector element's relative motion was allowed or constrained using a Fortran procedure. The on/off control was based on the current deformation of the middle of the span.

3.2.2. Results

In the first step an initial displacement of 16 cm was applied to the model and free vibrations of the system were calculated for the reference case. Then calculations were repeated with the control procedures added. The vertical displacement of the middle of the span is shown in Fig. 10.

It can be observed that 95% of the vibration amplitude is damped out after two cycles of vibration. The relative displacement between layers' ends shown on the picture is magnified 10 times. The attaching process creates an impact followed by higher frequency, local vibrations which are manifested with longitudinal vibrations of layers. These vibrations are successfully damped out with the structural damping.

After two cycles of disconnection/ reconnection of layers, the vibration of the first mode is considerably mitigated, while the higher modes become dominant. The second sequence of control activation is triggered close to the maximum accumulated strain, at the point where the deformation shape is of the first mode (see Fig. 11a). In order to maximize the effect, the "frozen" dislocation of layers should be maximized. Therefore the deflection peak, at which the control is to be activated should be chosen carefully, avoiding unfavorable deformation shapes, f.e. of the third mode (see Fig. 11b). In order to suppress higher modes of vibration more active members are required, thus more interfering in the structural integrity would be needed. Such a case could still be reasonable for some applications, but it has not been considered in this paper. For many applications, especially in slender structures, the majority of the vibration energy is transferred in the first few modes, making the fundamental mode mitigation an important task.

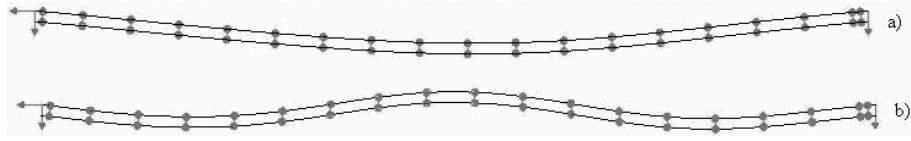

Fig. 11. Desired a) and undesired b) deformation shape for activating the control.

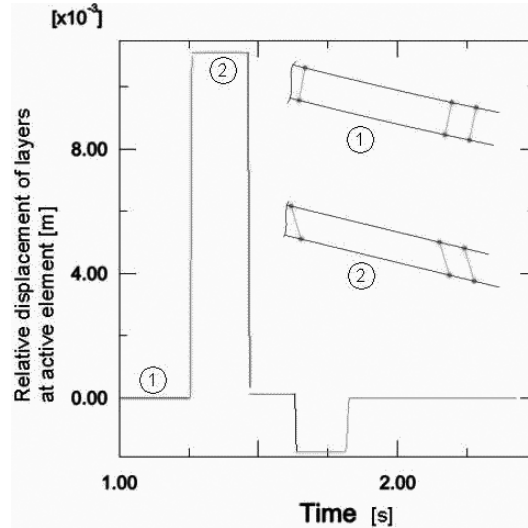

Fig. 12. Relative displacement of layers.

4. Experimental verification

4.1. Experimental set-up

In order to validate the efficiency of PAR strategy in vibration mitigation, a cantilever two layered beam has been chosen as a demonstrator. The experimental beam was submitted to free vibrations. The idea of the experiment was to control the delamination between layers. As described in numerical simulations section, the time during which layers are disconnected should be short as compared to the full oscillation period. Results were compared with a reference case in which layers were pressed together with the maximum force.

The experimental set-up consists of two adjacent aluminium bars clamped at the root. Bars are not connected with each other along the length, except at the tip, where they can be pressed together with the actuator device. The actuator used for the experiment consists of piezo stacks and a mechanical displacement amplifier [1]. The resulting stroke can reach 0.23 mm and the maximum force is about 1300 N. With this device layers can be pressed with enough force to hold them together during the deformation process.

The actuator state is updated basing on a piezoelectric sensor reading placed close to the cantilever root. General view of the set-up is shown in Fig. 13.

4.2. Control procedure

The process of adaptation of the system during free vibrations is based on a closed loop between the strain sensor reading and the voltage applied to piezo stacks of the actuator device. The process starts with the maximum voltage applied to piezo stacks, i.e. with maximum force holding layers together. The control algorithm recognizes a displacement peak at which the layers are disconnected for a time interval of 100 ms. The time interval at which the force is completely removed is significantly smaller in practice due to the internal constrains of the amplifier. In fact 100 ms interval was possibly the smallest at which the actual force could decrease to zero. Choice of the amplifier

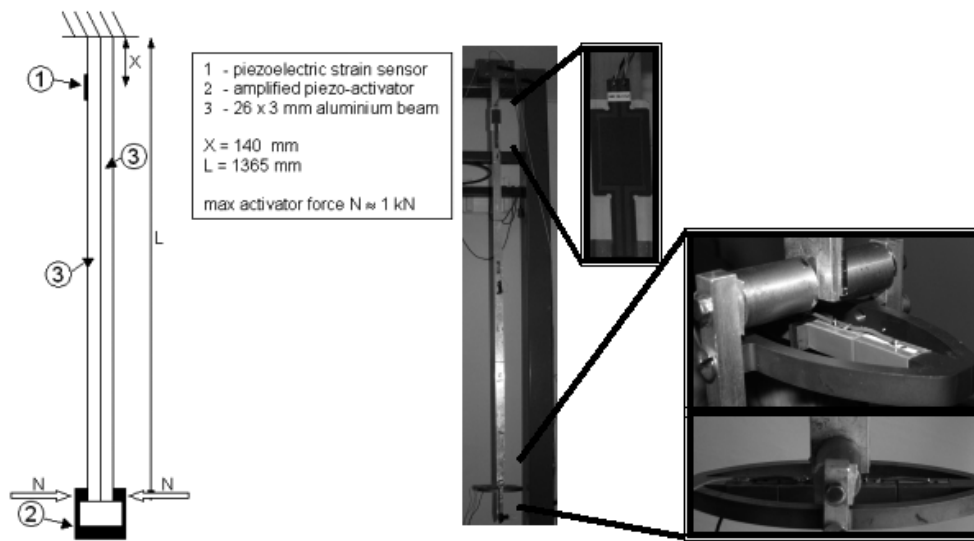

Fig. 13. Experimental set-up, detailed view of sensor and actuator.

was a compromise, where on one hand was possibly the fastest reaction time and on the other safety of piezo stacks which can be destroyed if too big current peaks were applied. After this layers are connected again, until the next displacement peak is recognized. The expected behavior of layers during activating control was described in the numerical simulations section. The control loop was updated with the sampling frequency of 100 Hz.

4.3. Results

4.3.1. Initial tests

In the initial stage the system was submitted to free vibrations without applying control procedure. First no voltage was applied to piezo stacks, and secondly maximum voltage was applied. The fundamental own frequency of both systems was identified. The resulting FFT spectra are shown in Fig. 14. A 22% change in the fundamental frequency of the structure can be observed, which means that the actuator state can significantly influence the response of the system.

4.3.2. Semi-active control

Free oscillations were introduced with the initial displacement of 10 cm applied at the tip of the cantilever. After few oscillations the control procedure was enabled. Then, after the delamination had been allowed in few displacement extrema (in this particular case in three consecutive peaks), the control procedure was disabled again. In the reference case the layers were pressed with constant force without any control action. Hence constant, maximum voltage was applied to piezo stacks regardless of the sensor reading. Results are shown in Fig. 15. Triggering the delamination in three consecutive peaks causes the vibration amplitude to be mitigated by over 80%. It can be seen that only threefold delamination has a substantial effect on the structural vibrations. The remaining amplitude could be further mitigated if the control was activated for longer period of time.

It has to be emphasized that the actual delamination time is much shorter than assumed 100 ms due the amplifier constraints. This means that the delamination, i.e. “weakening” of the structure is allowed during only few per cent of the total oscillation period. A typical difference between voltages generated and actually applied to the actuator is depicted in Fig. 16 a) and b) respectively.

The system under investigation has quite high structural damping, which can be seen in Fig. 15. Figure 17, in turn, illustrates the relative difference in amplitudes of the first 10 vibration peaks, as related to the reference case.

In order to release possibly the most strain energy the delamination has to coincide with the deformation peaks. Therefore the PAR efficiency is very sensitive to the time instant of the delamination. If it occurs too long before

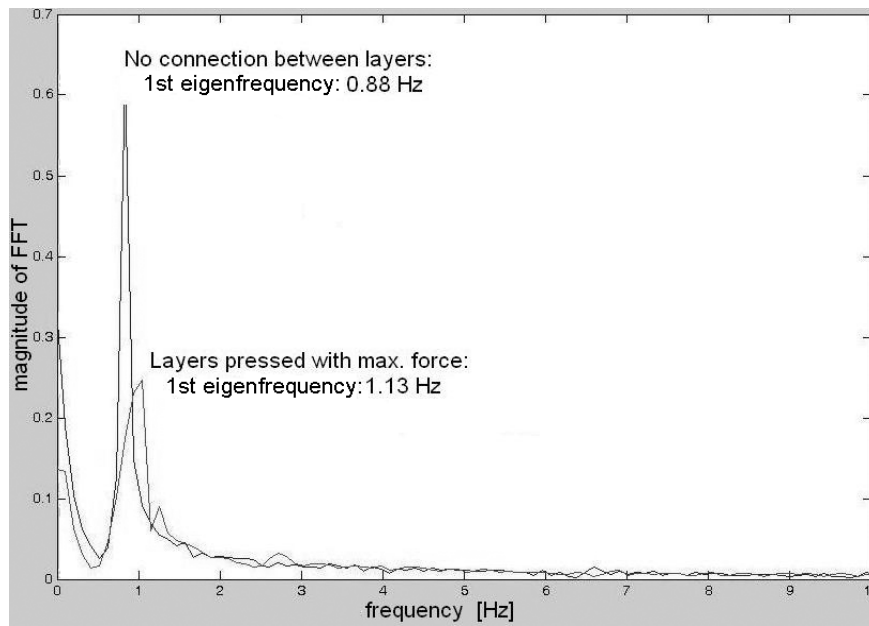

Fig. 14. 1st eigenfrequency shift between disconnected and connected layers.

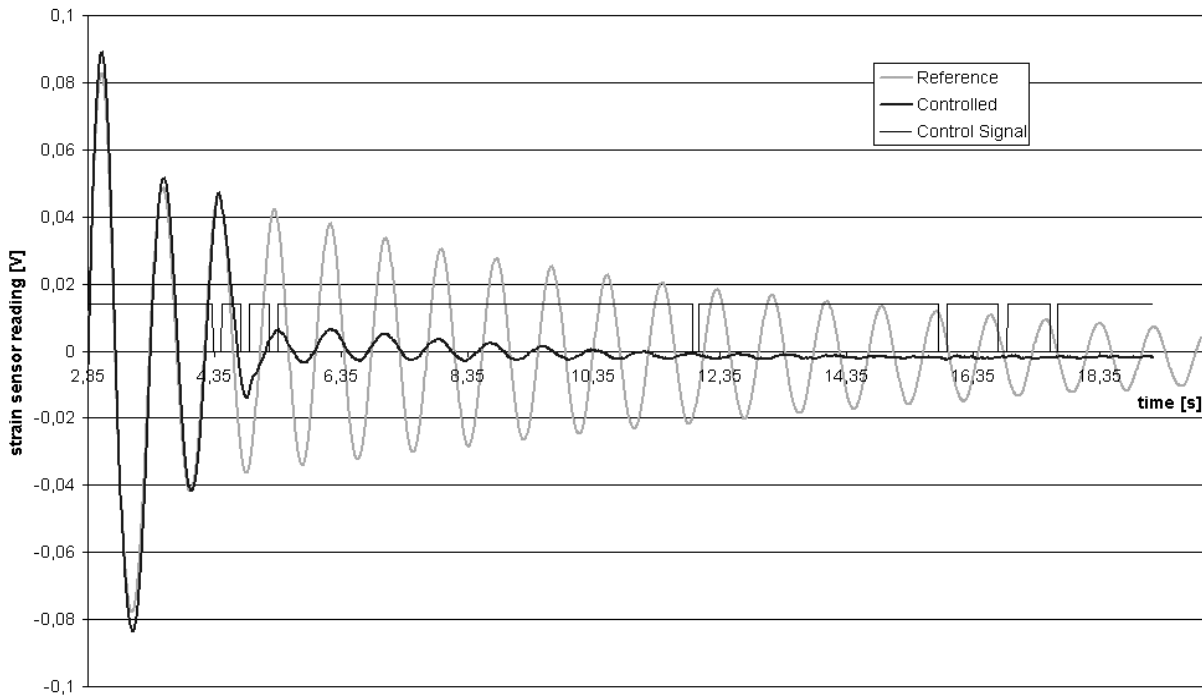

Fig. 15. Time history response of the system.

or after the maximum deflection then the obtained response mitigation is less significant. If, in the worst case the delamination occurs around the equilibrium position of the cantilever then there is no effect at all since there was no deformation incompatibilities between layers which could be “frozen”. Figure 18 shows no damping effect due to wrong delamination trigger time.

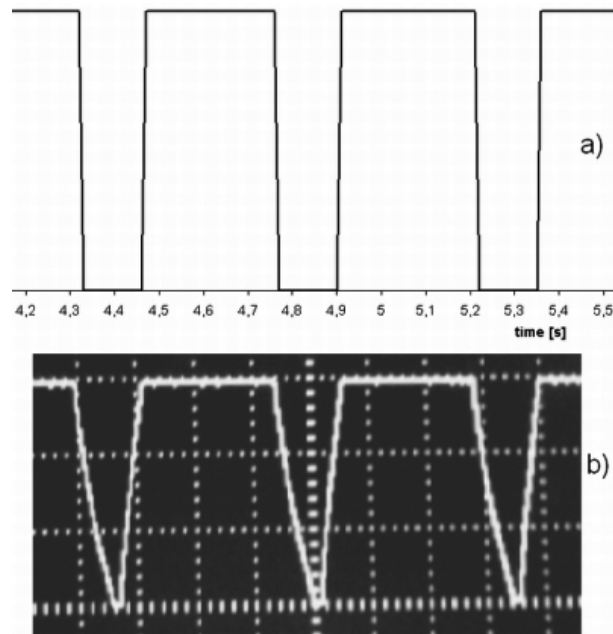

Fig. 16. a) voltage generated and b) actually applied to the piezo stacks.

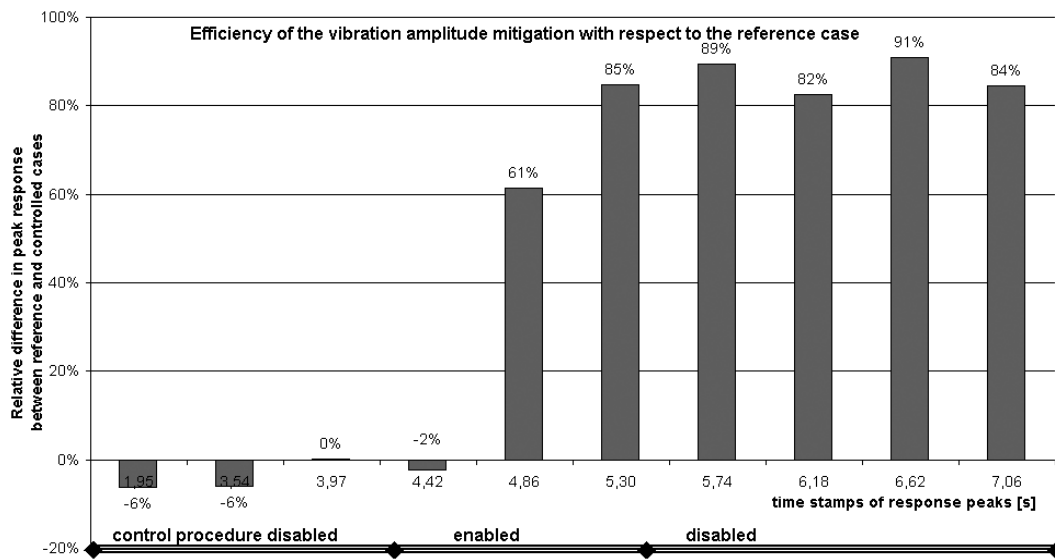

Fig. 17. Relative difference in amplitudes as related to the reference case.

5. Possible applications

Among possible applications are:

- Pedestrian bridges
- Pipelines
- Truss structures
- Small scale mechanical systems

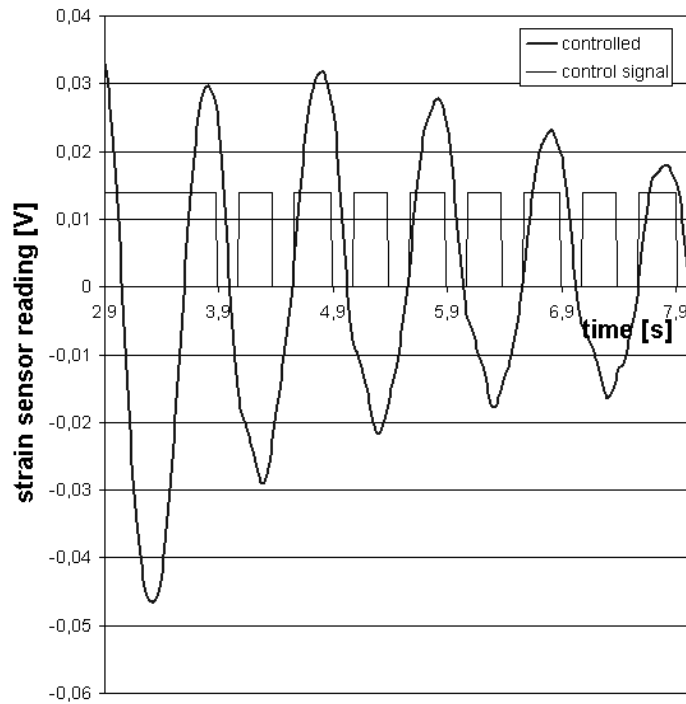

Fig. 18. Weak effect due to wrong delamination trigger time.

Two layered beam discussed in Section 3 has the span and stiffness of an experimental, light weight pedestrian bridge located in EMPA Laboratory, Switzerland. Cables sustaining the span, which completely change the dynamic behavior of the structure were not modeled in the numerical example. In order to effectively apply PAR strategy to this type of structures, mitigation of higher modes has to be accounted for. For this purpose only one active member at the support is not sufficient.

Detachable spring which was discussed in Section 2 could be used at the supports of pipeline systems in order to accumulate the deformation energy and convert it to kinetic energy which can be than dissipated.

Acknowledgements

The work was done as a part of the following projects:

- SAFE-STRUCT *New methods for design of safe structures with identification of hazards and active adaptation in critical states* Nowe metody projektowania bezpiecznych konstrukcji, uwzględniające identyfikację zagrożeń i aktywną adaptację w stanach krytycznych, 3T11F00930, 2006–2009
- Eko-Energia *Nowe, ekologiczne i bezpieczne technologie w wytwarzaniu i konwersji energii*

Parts of the paper will be incorporated into the book “*Smart Technologies for Safety Engineering*” edited by the third author, to be published by Wiley.

References

- [1] Cedrat Recherche Catalogue and: H. Bruneau, R. Le Letty, F. Barillet and N. Lhermet, *Application of a New Amplified Piezoelectric Actuator to sEmi-Active Control of Vibration*, Proc. 2nd Int. Conference MV2 on Active Control in Mechanical Engineering, Lyon, France, 1997.
- [2] S.J. Dyke, B.F. Spencer, Jr., M.K. Sain and J.D. Carlson, *Experimental Verification of Semi-Active Structural Control Strategies using Acceleration Feedback*, (Vol. 3), Proc. 3rd Intern. Conf on Motion and Vibration Control, Chiba, Japan, Sept 1–6, 1996, pp. 291–296.

- [3] L. Gaul, R. Nitsche and D. Sachau, *Semi-Active Vibration Control of Flexible Structures*, Proc. of the EUROMECH 373 Colloquium on Modelling and Control of Adaptive Mechanical Structure, 1998, Magdeburg, Germany.
- [4] J. Holnicki-Szulc and Z. Marzec, *Adaptive Structures with Semi-Active Interfac*, Proc. of the EUROMECH 373 Colloquium on Modelling and Control of Adaptive Mechanical Structures, 1998, Magdeburg, Germany.
- [5] F. dell'Isola and S. Vidoli, Damping of bending waves in truss beams by electrical transmission lines with PZT actuators, *Archive of Applied Mechanics* **68** (1998), 626–636.
- [6] D.C. Kamopp, M.J. Crosby and R.A. Harwood, Vibration control using semi active force generation, *Jour Of Engineering For Industry, ASME* **96**(2) (1974), 619–626.
- [7] T. Kobori, M. Takahashi, T. Nasu and N. Niwa, Seismic response controlled structure with active variable stiffness systems, *Earthquake Engineering and Structural Dynamics* **22** (1993), 925–941.
- [8] G.G. Lee, Z. Liang and M. Tong, *Development of a Semi-Active Structural Control System*. In *Research progress and Accomplishments 1997–1999*, Multidisciplinary Center for Earthquake Engineering Research MCEER, SUNY at Buffalo, NY, USA, July 1999.
- [9] D.F. Ledezma-Ramirez, N.S. Ferguson and M.J. Brennan, *Vibration decay using on-off stiffness control*, Proc. Of the ISMA International Conference on Noise and Vibration Engineering, Leuven, Belgium, September 2006.
- [10] Z. Marzec, J. Holnicki-Szulc and F. López-Almansa, *Strategy of Impulse Release of Strain Energy for Damping of Vibration*, Proc. NATO ARW Smart Structures'98, 1998, Pultusk, Poland.
- [11] W.N. Patten, J. Sun, G. Li, J. Kuehn and G. Song, Field test of an intelligent stiffener for bridges at the 1–35 Walnut Creek Bridge, *Earthquake Engineering and Structural Dynamics* **28**(2) (1999), 109–126.
- [12] A. Ruangrassamee and K. Kawashima, *Semi-Active Control of Bridges with use of Magnetorheological Damper*, Proc. of 12th European Conference on Earthquake Engineering, London England, Sept. 2002, paper n. 171, CD-ROM.
- [13] M.D. Symans and M.C. Constantinou, Semi-Active control systems for seismic protection of structures: a state-of-the-art review, *Engineering Structures* **21**(6) (1999), 469–487.
- [14] M.D. Symans, G.J. Madden and N. Wongprasert, *Experimental Study of an Adaptive Base Isolation System for Buildings*, Proc. of 12th World Conf on Earthquake Eng, 12WCEE, Auckland, New Zealand, 30 Jan.-4 Feb. 2000, paper n.1965, CD-ROM.



Hindawi

Submit your manuscripts at
<http://www.hindawi.com>

