

S. V. SHALUPAEV\*, M. ALEKSIEJUK\*\*, Y. V. NIKITJUK\*, A. A. SEREDA\*, A. S. POBIYAHA\*

## LASER THERMOSPLITTING OF CERAMIC-METAL SANDWICH-LIKE STRUCTURES WITH ACOUSTICAL SURVEILLANCE OF MICROCRACK PROPAGATION

### LASEROWE TERMOROZSZCZEPIANIE CERMETALOWYCH STRUKTUR SANDWICHOWYCH PRZY AKUSTYCZNEJ KONTROLI ROZPRZESTRZENIANIA SIĘ MIKROPEKNIĘĆ

In this article, a technology of sandwich-like structures division is offered. As a technological instrument, this technology combines the use of radiation of a solid-state laser on yttrium aluminum garnet (YAG) with the wavelength 1.06  $\mu\text{m}$ , whose intensity is allocated in the depth of the ceramic-metal, in accordance with the law of Buger-Lambert-Berr, and the use of radiation of a CO<sub>2</sub>-laser with the wavelength 10.6  $\mu\text{m}$ , for which the ceramic-metal is not transparent.

*Keywords:* laser cutting, ceramic substrate, sandwich-like structures, acoustical surveillance

W artykule proponowana jest technologia podziału struktur sandwichowych. Jako instrument technologiczny, technologia ta łączy wykorzystanie promieniowania laserem stałym granatu itrowo-aluminiowego (YAG), przy długości fali 1.06  $\mu\text{m}$ , którego natężenie zlokalizowane jest w głębi spieku ceramicznego, zgodnie z prawem Lamberta-Berra oraz zastosowanie promieniowania laserem CO<sub>2</sub> o długości fali 10.6  $\mu\text{m}$ , dla którego spiek metaliczny nie jest przezroczysty.

## 1. Introduction

Modern technologies widely use various products made of ceramics, semiconducting materials and metals. Among them cermet products are the most perspective due to their high mechanical strength, the ability to withstand high temperatures and thermal blows. Such products include ceramic substrates for hybrid integrated circuits with shield the metalized surface. Today's technologies of handling such materials in microelectronics and instrument-making are based on the use of abrasive machine tools. The modes of cutting are set empirically, on the basis of the mechanical properties of the materials, the geometrical dimensions and the requirements for their precision. The other methods of dimension treatment (thermal, chemical, electric erosion, chemical catalytic, ultrasound) haven't found a wide application in industrial technologies because of their low productivity and the difficulties in their realization in industry [1]. In this respect, the necessity to study the processes of laser thermosplitting of ceramic-metal structures arises.

Most today's methods of laser thermosplitting of brittle non-metallic materials use the CO<sub>2</sub>-laser as a tech-

nological instrument, and its wavelength lies beyond the range of transparency of most brittle non-metallic materials. Solid-state lasers with the wavelength of 1.06  $\mu\text{m}$  for highly precise handling of brittle non-metallic materials (including alumina ceramics) haven't found a wide application, as the losses in the handled material of the wavelength radiation are small and it makes the handling inefficient because of the slow formation of the splitting microcracks. On the other hand, the method allows to process materials with big thickness, due to the voluminosity of its absorption in various non-metallic materials. Yet there is one more thing that limits the method of handling brittle non-metallic materials with the use of laser radiation, with the 10.6  $\mu\text{m}$  wavelength, which is absorbed in the surface layer of the handled material. It is the precision of splitting [2].

Thus, working out the method of highly precise handling of brittle non-metallic materials that provides the possibility of qualitative splitting of cermet products becomes very important. For this purpose, in the present paper, we suggest the use of the two-beam method of laser thermosplitting of brittle non-metallic materials,

\* DEPARTMENT OF PHYSICS, F. SKORINA GOMEL STATE UNIVERSITY, SOVETSKAYA STREET 104, 246019 GOMEL, REPUBLIC OF BELARUS

\*\* INSTITUTE OF FUNDAMENTAL TECHNOLOGICAL RESEARCH PAS, 02-106 WARSZAWA, 5B PAWIŃSKIEGO STR., POLAND

combining the application of the solid-state YAG-laser and CO<sub>2</sub>-laser.

**2. Laser cutting system and experiments of laser cutting of ceramic-metal sandwich-like structures**



Fig. 1. Laser technological complex

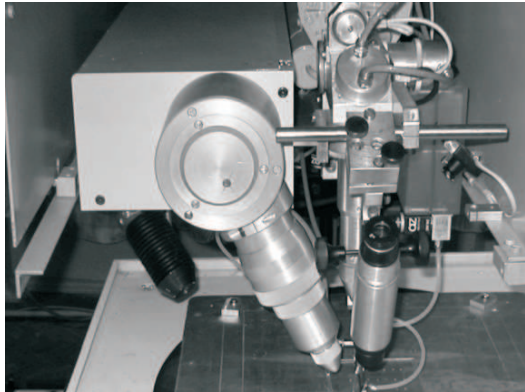

Fig. 2. The view of the working area

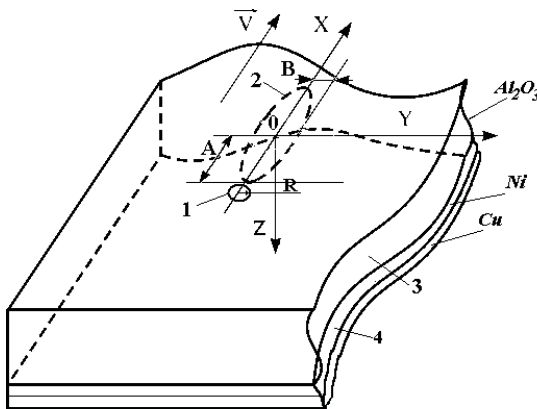

Fig. 3. The allocation scheme of laser beams in the plane of handling

The experimental researches have been done on the laser technological complex that has been created by the authors [3-4]. It includes module constructions of both YAG- and CO<sub>2</sub>-lasers joint into an optical system of converging and focusing radiation. Fig. 1 shows the general

view of the complex of the two-beam handling, Fig. 2. – the view of the working area.

Fig. 3 shows the allocation of the laser beams in the plane of handling. Point 1 indicates the laser beam with the wavelength  $\lambda = 1.06 \mu\text{m}$ , point 2 marks the laser beam with wavelength  $\lambda = 10.6 \mu\text{m}$ , point 3 marks the ceramic layer, point 4 – the metal layer. Ceramic-metal plates of 0.8 and 1.6 mm thickness with two-layer nickel-copper coating have been used for studying the modes of the two-beam thermosplitting.

The obtained experimental results allow to conclude that the application of the two-beam method improves the quality and accuracy of handling. The thermosplitting of the ceramic-metal plates was carried out as follows (see Fig. 3): the product being handled was moved by the positioning device with regard to the stationary laser beams 1, 2 in the direction shown by the horizontal arrow. Laser beam 1 passing through the layer of alumina ceramics is partially absorbed and dissipated, which leads to the volume heating of the sample. Then the rest of the YAG-laser radiation is absorbed in metal layer 4, which results in the formation of a surface heat source on the metal-ceramics border. The radiation of CO<sub>2</sub>-laser beam 2, absorbed in the surface layer of the ceramics, also heats it. Thus, the ceramic-metal plate is heated by the local surface heat source in the point of the CO<sub>2</sub>-laser radiation impact, by the volume source formed by the laser radiation with the wavelength of 1.06  $\mu\text{m}$ , whose intensity in the depth is distributed in accordance with the law of Buger-Lambert-Berr, and by the local source on the metal-ceramics border formed as a result of the absorption of the YAG-laser radiation that passed through the layer of alumina ceramics by the metal layer.

The module (Fig. 4) has been developed in order to control the microcrack propagation during the controllable laser thermosplitting of brittle nonmetallic materials. The operation of this module is based on the method of acoustic emission – the process of elastic waves appearance as a result of the energy surge out of the local sources in the structure of the material.

Piezoceramic transducer registers elastic waves. Further, the signal intensifies and mixes with a heterodyne signal. As a result, we get oscillations with acoustical range frequencies and then we transmit it to the personal computer for further analysis. The analysis of the frequency spectrum and the acoustic signal intensity obtained during the one-beam and two-beam thermosplitting of ceramic-metal plates shows that the radiation of the YAG-laser makes considerable contribution to the distribution of elastic stresses inside the sample and also, it increases the stability of the microcrack nucleation and the crack propagation deep into the sample.

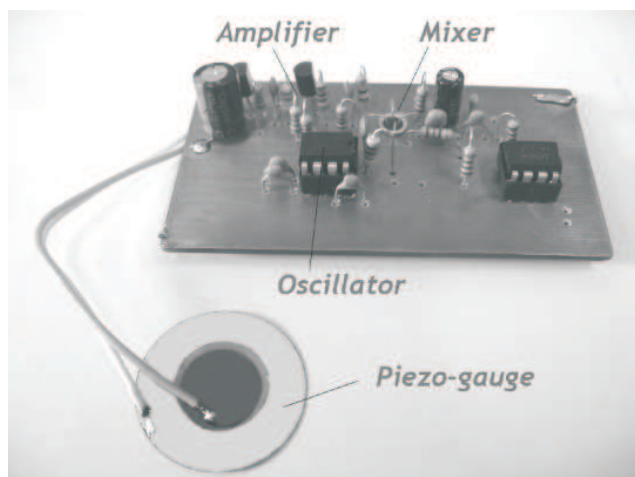

Fig. 4. Module of acoustical surveillance of microcrack

### 3. Finite element analysis

To study the mechanism of the two-beam impact on brittle non-metallic materials, the necessity of conducting numeric modeling of the two-beam process arises. The analysis of the literature has shown that there is a number of sources with the study of the features of heating of non-metallic materials under the impact of laser radiation [5-9]. The analysis of the peculiarities of semiconductors heating under the two-frequency laser impact that has been done in [10-11] reveals the possibility of a wide control of the temperature fields structure in the sample volume. The work [12] discloses a joint impact of two radiations on the thresholds of the impulse optical disruption of the gallium arsenide surface and offers a model that qualitatively explains the phenomenon. The work [13] suggests a joint use of laser radiations of dif-

ferent frequencies to produce a p-n junction. Yet it is necessary to say that the works mentioned above give the solution of the problems concerning only the possible configurations of the temperature field structure. However, to reveal the features of the thermosplitting mechanism, the information about the distribution of the elastic stresses that occur in the material under handling is determinative.

According to the model of the process mentioned above, the ceramic plate is heated by two local sources on the surface of alumina ceramics and on the ceramics-metal border, correspondingly, and a volume source is formed by the laser radiation with the wavelength of  $1.06 \mu\text{m}$ , whose intensity is allocated in the depth, in accordance with the law of Bugar-Lambert-Berr.

Taking into consideration the volume absorption of the laser radiation with the wavelength of  $\lambda = 1.06 \mu\text{m}$  in a quasi-static target setting [14], we obtained the finite element solution of the problem of distribution of elastic fields under heating a ceramic metal sample by laser source.

To calculate the heat irradiation, we measured the extinction ratio. It is formed by the factor of true absorption characterizing the part of the absorbed radiant energy, and the factor characterizing the energy losses of the primary beam, due to the other processes, and above of all, the process of dispersion. The factor has been calculated by means of measuring the transmission of the YAG-laser radiation by alumina ceramic plates of different thickness without metal coating, with the help of the IMO-2M laser power meter, according to the scheme given in [7].

The thermal characteristics of the materials that form the ceramic metal articles which we have used for calculations are given in Tab.1. [15].

TABLE 1

Thermal and mechanical parameters of the materials

Characteristics	Alumina ceramic	Nickel	Copper
Density, $\text{kg/m}^3$	3960	8900	8930
Specific heat, $\text{J/kg}\cdot\text{K}$	760	440	380
Coefficient of thermal expansion, $10^{-7} (1/^\circ\text{C})$ .	80.0	155.6	191.5
Modulus of elasticity, GPa	380.0	202.9	112.0
Poisson's ration	0.222	0.300	0.358

The calculations have been done for a three-layer plate with the dimensions of the ceramic substrate  $20 \times 10 \times 0.8 \text{ mm}$  and  $20 \times 10 \times 1.6 \text{ mm}$ , and the metal layers were  $0.02 \text{ mm}$  thick each. The calculations have been done for the following parameters of laser beams: a big

axle  $A = 2 \cdot 10^{-3} \text{ m}$ , a small axle  $B = 0.5 \cdot 10^{-3} \text{ m}$  for the beam with the wavelength  $\lambda = 10.6 \mu\text{m}$  and the radiation power  $P = 60 \text{ W}$ ; the radius of the radiation spot of the YAG-laser  $R = 200 \mu\text{m}$  and the radiation power  $P_0 = 30 \text{ W}$ . For the calculations we have

used the finite element model of the three-layer material: ceramics-nickel-copper. The ceramic layer was 0.8 mm and 1.6 mm thick, and the metal layers were 40 μm thick. The travelling speed of the sample with regard to the laser beams was 30 mm/sec.

For the comparative analysis we have calculated the distribution of the thermo-elastic fields for the separate impact of the CO<sub>2</sub>-laser on a ceramic metal article with the ceramic layers of 0.8 mm and 1.6 mm thick. For the calculations we have used the same technological parameters as for the two-beam processing.

Figure 5 gives the distribution of the temperature fields on the surface of the sample ( $Z = 0$ ), in its middle ( $Z = H/2$ ) and on the metal-ceramics border ( $Z = H$ ) for the two-beam processing of metal ceramic plates  $H = 0.8$  mm thick. The firm lines show the isotherms with the temperature values.

As we can see from the picture, the maximum calculated temperature values do not exceed 610 °C. It makes difficult the relaxation of stresses that occur in the defects of the alumina ceramics structure because of the plastic deformations and it facilitates the thermosplitting of the ceramic metal sample, due to the spread of the main crack. In the middle of the sample the temperature is determined both by the subsiding impact of the CO<sub>2</sub>-laser and by the influence of the volume absorption of the YAG-laser radiation with the wavelength  $\lambda = 1.06$  μm by the material. On the ceramics-metal border the CO<sub>2</sub>-laser radiation does not practically affect the temperature values, and the latter are determined by the considerable heat irradiation in the metal layer, due to the high absorption of the YAG-laser radiation with the wavelength  $\lambda = 1.06$  μm, and by the additional volume heating of the adjacent ceramics layers by the same radiation. In this case, the influence of the latter effect in the sample with the alumina ceramic layer of  $H = 0.8$  mm in thickness is considerable and it is almost unnoticeable in the sample with the alumina ceramic layer of  $H = 1.6$  mm in thickness. The resulting temperature on the ceramic-metal border under the two-beam processing does not exceed the temperature inside the sample. This considerably distinguishes this case from the case of the CO<sub>2</sub>-laser impact, where the temperature evenly drops with the radiation spreading in the deeper layers of the ceramic metal.

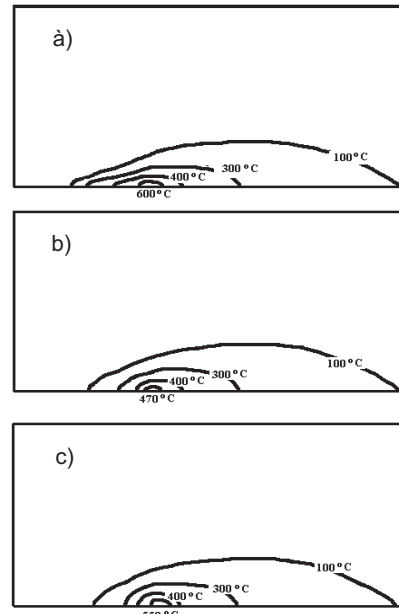

Fig. 5. The distribution of temperature fields under the two-beam handling,  $H=0.8$  mm a)  $z=0$ ; b)  $Z=H/2$ ; c)  $z=H$

Figure 6 shows the distribution of stresses  $\sigma_{yy}$  during the two-beam processing of the ceramic-metal plates of  $H=0.8$  mm thick in the plane  $Y=0$  along the  $X$  axis (see figure 3). The curve  $0H$  corresponds to the points on the surface of the sample ( $Z=0$ ), the curve  $H/2$  corresponds to the points in the middle of the sample ( $Z=H/2$ ), the curve  $H$  corresponds to the points on the ceramics-metal border. Figure 7 shows a similar distribution of stresses  $\sigma_{yy}$  during the two-beam processing of the ceramic-metal plates of  $H=1.6$  mm thick. The curve  $H/4$  corresponds to the points at the depth  $Z=H/4$  from the surface of the sample. Figures 8 and 9 show the distributions of stresses  $\sigma_{yy}$  during the one-beam processing of the ceramic-metal plates of  $H=0.8$  mm and  $H=1.6$  mm thick, respectively. The beam centers of CO<sub>2</sub>-and YAG-lasers on the  $X$  axis are focused on the marks 0.45 cm and 0.65 cm, respectively.

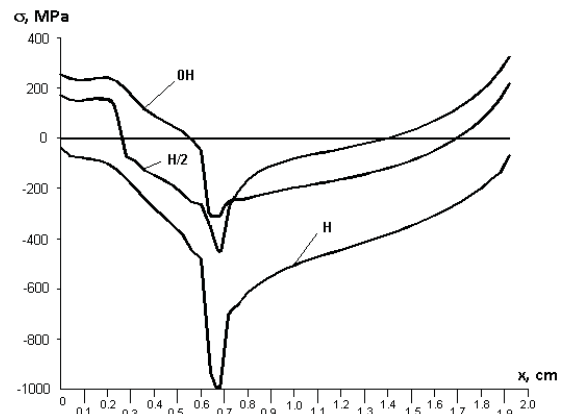

Fig. 6.  $\sigma_{yy}$  stress-displacement curve along  $X$  axis under the two-beam handling,  $H=0.8$  mm

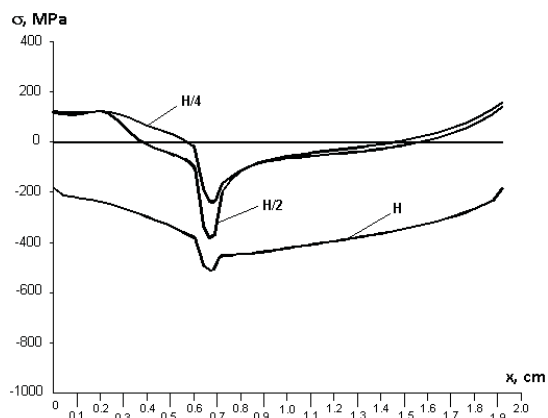

Fig. 7.  $\sigma_{yy}$  stress-displacement curve along X axis under the two-beam handling,  $H=1.6$  mm

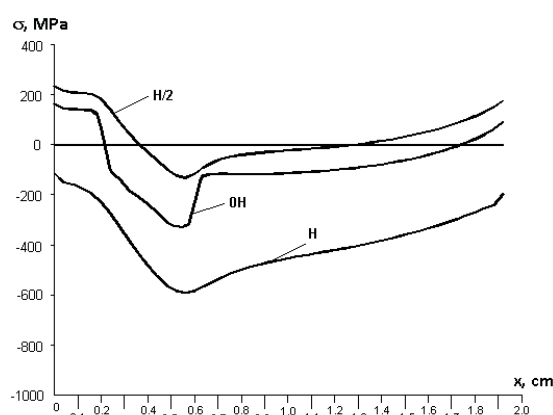

Fig. 8.  $\sigma_{yy}$  stress-displacement curve along X axis under the one-beam handling,  $H=0.8$  mm

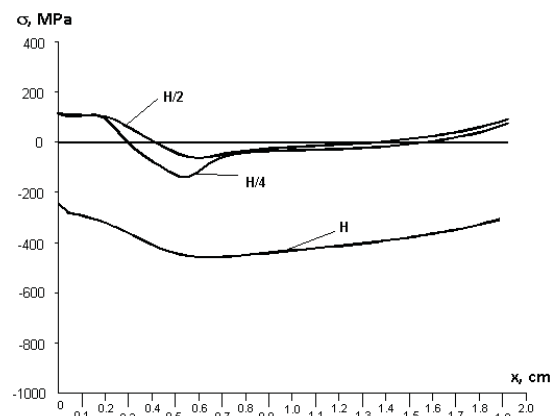

Fig. 9.  $\sigma_{yy}$  stress-displacement curve along X axis under the one-beam handling,  $H=1.6$  mm

As we can conclude from the above figures, the contribution of the  $\text{CO}_2$ -laser radiation and the YAG-laser radiation to the final distribution of stresses in various depths differs greatly. On the sample surface, the stresses formed by the  $\text{CO}_2$ -laser radiation have high values. However, in the middle of the sample, the stresses formed by the YAG-laser radiation are characterized by higher values and the values of the stresses on the

ceramics-metal border are rather high, due to the absorption of the laser radiation with the wavelength of  $\lambda = 1.06 \mu\text{m}$  by the metal layer.

Besides, it should be emphasized that in the case of handling thin ceramic metal plates, the values of the stresses formed by the  $\text{CO}_2$ -laser are sufficient for the crack initialization and the application of the two-beam technology provides a higher quality only. As for the handling of thicker samples, the two-beam technology is absolutely necessary to obtain an adequate result, as in this case, the values of the stresses formed by the  $\text{CO}_2$ -laser are not sufficient for the crack initialization.

In the case of the  $\text{CO}_2$ -laser impact, only the stresses that occur on the ceramics-metal border are not high enough to maintain the controlled growth of the crack. Besides, it is possible to increase the radiation power because it leads to the exceeding of the maximum permissible values of temperature on the surface of the material, which makes the brittle distraction possible. At the same time, when using the two-beam technology in the sample with alumina ceramics layer of  $H=1.6$  mm in thickness, considerable stresses appear at the depth of 0.8 mm and this can determine the direction of the splitting crack growth.

It should be noted that in the area of the YAG-laser impact, the distribution of stresses  $\sigma_{zz}$  acting transversally to the material surface is characterized by the increase in the stress values on the undesirable separation of the metal layers from the alumina ceramics.

#### 4. Conclusions

The analysis of thermoelastic fields enables us to conclude that the formation of a splitting crack along the line of the laser impact takes place in the upper layers of the alumina ceramics and is determined first of all by the stresses formed by the laser radiation with the wavelength of  $10.6 \mu\text{m}$ . However, the analysis of the stress distributions in the deeper layers of the material discloses the leading role of the stresses formed by the laser radiation with the wavelength of  $1.06 \mu\text{m}$  in the further development of the splitting crack at the depth of the material. Besides, the stresses provide the decrease in the deviation of the crack from the plane of separation and its more vertical orientation both on the ceramics-metal border and in the upper layers of the alumina ceramics.

#### REFERENCES

- [1] A. Ya. N a s h e l s k y, The Technology of Semiconductors, M. Metalurgiya 336, 2 (1987).

- [2] A. M. Sarzhevsky, Optics, Minsk: the Universitetskoye Publishing House **2**, 317, 3 (1986).
- [3] S. V. Shalupaev, E. B. Shershnev, Yu. V. Nikitjuk, The Installation for Laser Thermosplitting of Brittle Non-Metallic Materials, Patent 683 RB (2002).
- [4] S. V. Shalupaev, E. B. Shershnev, Yu. V. Nikitjuk, I. M. Kamornikov, A. A. Sereda, I. L. Poltoran, The Installation for Laser Cutting of Brittle Non-Metallic Materials, Patent 1979 RB (2005).
- [5] S. V. Shalupaev, A. V. Semchenko, Y. V. Nikitjuk, Silica gel glasses after laser radiation, Material Science **21**, 4, 495-501 (2003).
- [6] S. V. Shalupaev, E. B. Shershnev, Yu. V. Nikitjuk and etc, Laser Thermosplitting of Dielectrics, Ceramics. Polish Ceramics Bulletin **65**, 75-83 (2001).
- [7] B. V. Bokut, A. V. Maksimenko, A. T. Malashchenko, V. N. Myshkovets, G. N. Pokatashkin, V. N. Rudkovsky, The Increase of Efficiency of Laser Cutting of Dielectrics with Metal Coating, «Electronic Engineering», serie 7 – Technology, Organization of Production and Equipment **4**, (149), 3-5 (1988).
- [8] S. V. Shalupaev, A. V. Maksimenko, V. N. Myshkovets, Yu. V. Nikitjuk, Laser Cutting of Ceramics Materials with Metallized Coating, Optical Journal **68**, 10, 41-44 (2001).
- [9] V. S. Aleinikov, V. I. Masichev, The Optimization of Technological Processes of Glass Thermal Treatment in the Production of Valves by Means of Their Volume Heating with the CO-laser, Electronic engineering. Series 7. Technology, Organization of Production and Equipment **13**, (1553), 45 (1990).
- [10] S. A. Kakorin, V. L. Komolov, M. N. Libenson, The Peculiarities of Light Excitation and Temperature distribution in Semiconductor under Two-Frequency Counter Impact, Letters in ZTF **8**, 9, 513-517 (1982).
- [11] V. L. Komolov, M. N. Libenson, G. D. Shandibina, Heating and Laser Destruction of Semiconductors, News AC USSR **49**, 6, 1103-1110 (1985).
- [12] A. M. Bonch-Bruevich, A. I. Bumyalis, V. L. Komolov and etc, Optical Disruption of Galium Arsenid Under Impulse Two-Frequency Letters in ZTF **8**, 8, 507-510 (1982).
- [13] S. G. Kiyak, M. N. Libenson, G. V. Plyatsko, A. A. Chelnyy, Method of p-n Junction Production in Doped Semiconductor Materials, Patent 1042523 USSR (1983).
- [14] V. Novatskiy, Elasticity Theory, M.: Mir, 872 (1975).
- [15] I. K. Kikoin, V. G. Averin, B. A. Arozon, The Tables of Physical Quantities: Reference Book, M.: Atomizdat, 1008 (1976).